

## Electric cylinders EPCO, with spindle drive

**FESTO**



## Characteristics

### At a glance

#### General information

The electric cylinder EPCO is a mechanical linear drive with piston rod and permanently attached motor. The driving component consists of an electrically actuated spindle that converts the rotary motion of the motor into linear motion of the piston rod.

#### Features

- With ball screw
- Available with female thread
- Available with holding brake
- Degree of protection IP40
- Compact dimensions
- Extensive mounting accessories for various installation situations

#### Application areas

- Suitable for simple applications in factory automation that in the past were mostly carried out using pneumatic solutions

### Optimised Motion Series (OMS)

A package that makes positioning easier than ever before.

The Optimised Motion Series is as easy to handle as a pneumatic cylinder, but with the functionality of an electric drive.



#### Simple selection

- Easy sizing and selection using cycle time charts
- No special knowledge of electric drive technology required

#### Ordering and logistics

- All the necessary individual parts under a single part number
- Motors mounted on electric cylinders

#### Quick to configure

- Parameterisation and commissioning via web server/browser
- Parameterise up to 7 freely definable positions directly on the PC

### For simple positioning tasks

Electric cylinder EPCO



Motor controller CMMO-ST



## Characteristics

### Motor mounting variants

EPCO-16

Standard

Right (characteristic R)

Underneath (characteristic D)

Left (characteristic L)

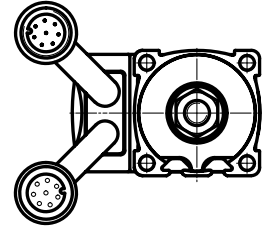
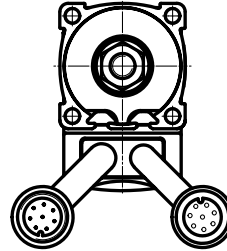
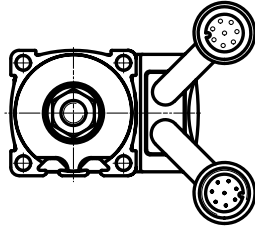
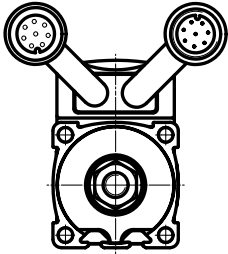

EPCO-25/-40

Standard

Right (characteristic R)

Underneath (characteristic D)

Left (characteristic L)

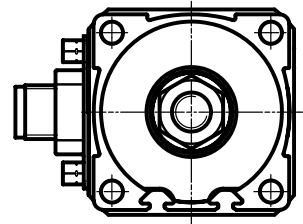
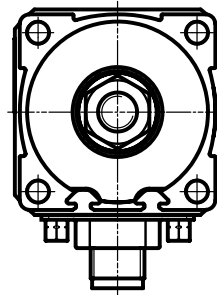
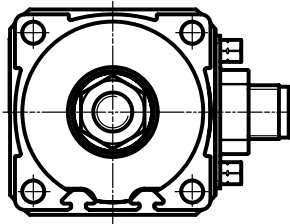
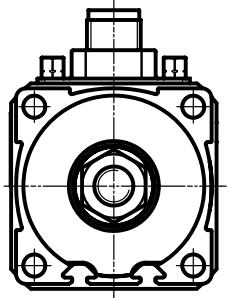

### Electric cylinder EPCO with guide unit EAGF-P1



The guide unit provides protection from torsion in the case of high torque loads. It offers a high level of guide precision for workpiece handling and other applications.

The guide unit can optionally be ordered via the modular product system.

Integrated mounting interfaces permit direct mounting with numerous multi-axis combinations, such as with:

- Toothed belt axis ELGR
- Rotary drive ERMO
- Mini slide DGSL

Technical data

→ Page 15

Ordering data

EPCO with guide unit EAGF assembled → page 26

Guide unit EAGF as an accessory → page 35

## Characteristics

### Combination options within the Optimised Motion Series (OMS)

Electric cylinder EPCO on toothed belt axis ELGR

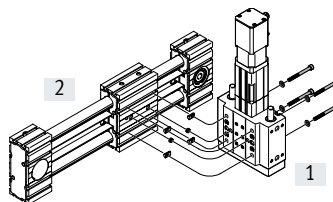
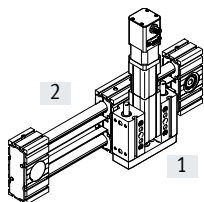

Size		Accessories			
[1] EPCO	[2] ELGR	Slot nut	Centring sleeve	Screw	Washer
16	35	NST-3-M3 (x4)	ZBH-7 (x2)	M3x10 (x4)	-
25	45	NST-5-M5 (x4)	ZBH-7 (x2)	M5x50 (x4)	DIN125-A5.3 (x4)
40	55	NST-5-M5 (x4)	ZBH-7 (x2)	M5x65 (x4)	DIN125-A5.3 (x4)

### Rotary drive ERMO on electric cylinder EPCO

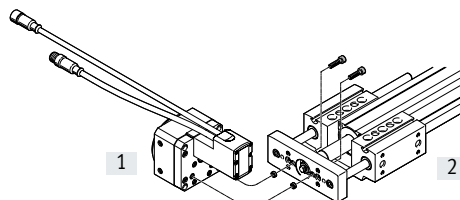
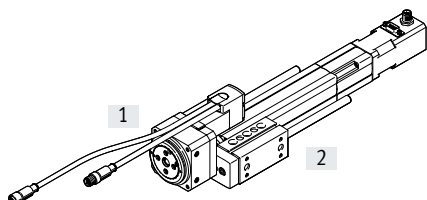

Size		Accessories	
[1] ERMO	[2] EPCO	Centring sleeve	Screw
12	16	ZBH-7 (x2)	M4x16 (x2)
16	25	ZBH-7 (x2)	M5x18 (x2)
25	40	ZBH-7 (x2)	M5x20 (x2)

### Rotary drive ERMO on mini slide DGSL

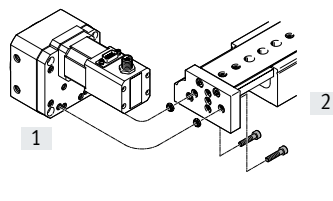
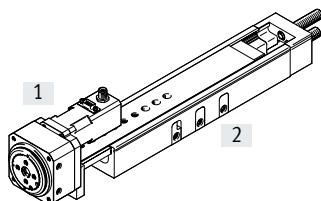

Size		Accessories	
[1] ERMO	[2] DGSL	Centring sleeve	Screw
12	12	ZBH-7 (x2)	M4x18 (x2)
25	20	ZBH-9-7 (x2)	M5x22 (x2)
25	25	ZBH-9-7 (x2)	M5x22 (x2)

### Rotary drive ERMO on mini slide EGSL

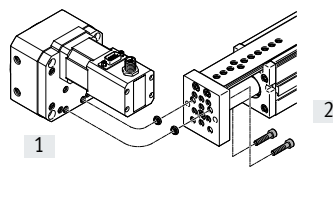
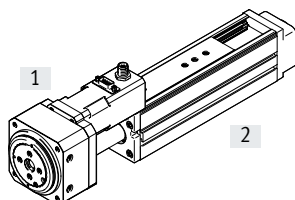

Size		Accessories	
[1] ERMO	[2] EGSL	Centring sleeve	Screw
12	35	ZBH-7 (x2)	M4x12 (x2)
16	45	ZBH-7 (x2)	M5x12 (x2)
25	55	ZBH-7 (x2)	M5x14 (x2)
32	55	ZBH-7 (x2)	M5x14 (x2)

## Characteristics

### Combination options within the Optimised Motion Series (OMS)

Electric cylinder EPCO on electric cylinder EPCO, horizontal

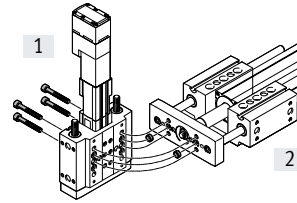
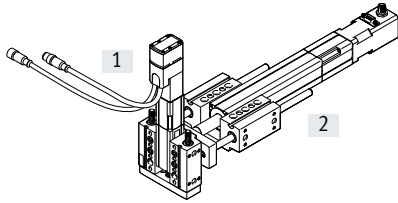

Size		Accessories	
[1] EPCO	[2] EPCO	Centring sleeve	Screw
16	25	ZBH-9 (x2)	M6x40 (x4)
25	40	ZBH-9 (x2)	M6x55 (x4)

Electric cylinder EPCO on electric cylinder EPCO, vertical

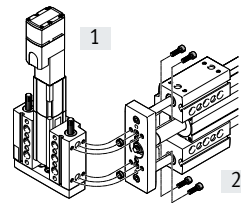
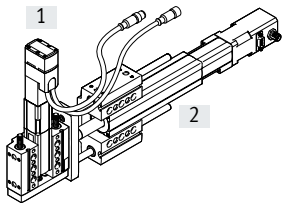

Size		Accessories	
[1] EPCO	[2] EPCO	Centring sleeve	Screw
16	25	ZBH-9 (x2)	M5x18 (x4)
25	40	ZBH-9 (x2)	M5x22 (x4)

Mini slide DGSL on electric cylinder EPCO

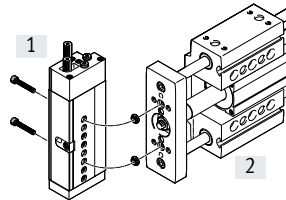
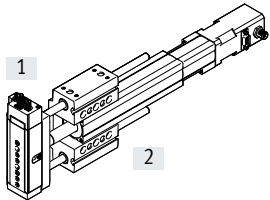

Size		Accessories	
[1] DGSL	[2] EPCO	Centring sleeve	Screw
8 (40 mm) <sup>1)</sup>	16	ZBV-9-7 (x2)	M4x16 (x2)
10 (30 mm) <sup>1)</sup>	25	ZBV-9-7 (x2)	M4x20 (x2)
12 (40 mm) <sup>1)</sup>	40	ZBV-9-7 (x2)	M5x20 (x2)

1) Minimum stroke

Peripherals overview

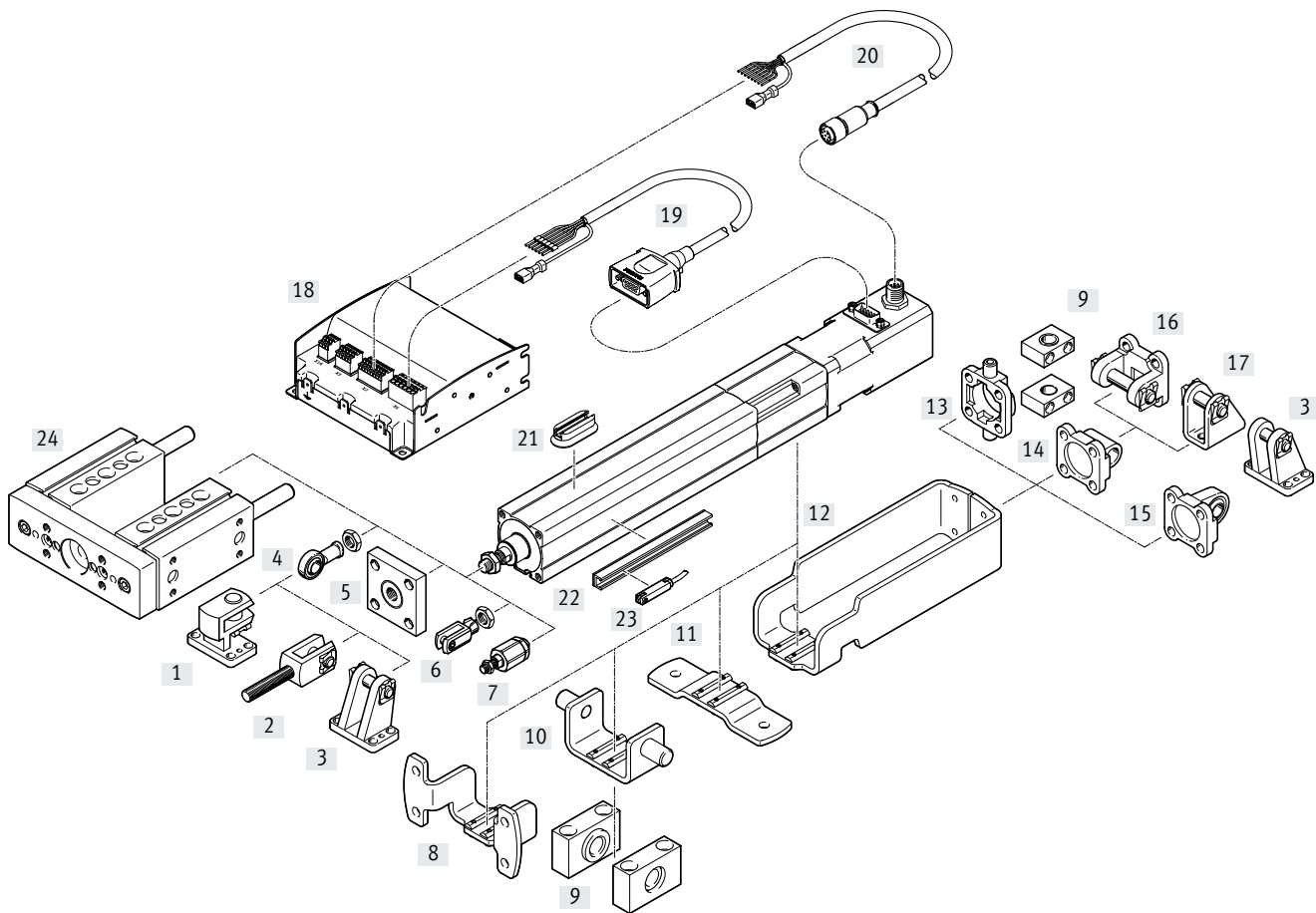

**Mounting components and accessories**

	Description	For size			→ Page/Internet
		16	25	40	
[1]	Right angle clevis foot LQG	-	-	■	34
[2]	Rod clevis SGA	-	-	■	35
[3]	Clevis foot LBG	-	-	■	34
[4]	Rod eye SGS/CRSGS	■	■	■	35
[5]	Coupling piece KSG	-	-	■	35
[6]	Rod clevis SG/CRSG	■	■	■	35

## Peripherals overview

Mounting components and accessories		Description	For size			→ Page/Internet
			16	25	40	
[7]	Self-aligning rod coupler FK	For compensating radial and angular deviations	■	■	■	35
[8]	Flange mounting EAHH	<ul style="list-style-type: none"> <li>For mounting the electric cylinder via the profile</li> <li>Position freely selectable along the cylinder length</li> </ul>	■	■	■	29
[9]	Trunnion support LNZG	For mounting the cylinder in combination with swivel mounting or trunnion flange	■	■	■	32
[10]	Swivel mounting EAHS	Position freely selectable along the cylinder length	■	■	■	30
[11]	Foot mounting EAHF	Position freely selectable along the cylinder length	■	■	■	28
[12]	Adapter kit EAHA	For mounting swivel flange and trunnion flange on the front side. When using the adapter kit, the motor connection must be mounted facing upwards or downwards.	■	■	■	31
[13]	Trunnion flange ZNCF	For spherical bearing. It cannot be mounted when turned by 90°.	–	–	■	32
[14]	Swivel flange SNCL	For spherical bearing	■	■	■	33
[15]	Swivel flange SNCS	For spherical bearing	–	–	■	33
[16]	Swivel flange SNCB/SNCB...-R3	For spherical bearing	–	–	■	34
[17]	Clevis foot LBN	For spherical bearing	■	■	■	34
[18]	Motor controller CMMO	For parameterising and positioning the electric cylinder	■	■	■	38
[19]	Motor cable NEBM	For connecting motor and controller	■	■	■	38
[20]	Encoder cable NEBM	For connecting encoder and controller	■	■	■	38
[21]	Mounting kit CRSMB	For proximity switches SME/SMT-8	■	■	■	37
[22]	Sensor rail SAMH	<ul style="list-style-type: none"> <li>For proximity switches SME/SMT-8</li> <li>Size 25 only with proximity switch SMT-8</li> </ul>	■	■	■	37
[23]	Proximity switches SME/SMT-8	For homing or position sensing	■	■	■	36
[24]	Guide unit EAGF-P1	For protecting electric cylinders against torsion at high torque loads	■	■	■	35

**Note**

In the case of high loads, mounting should not just be using the mounting threads on the front.

The mass of the motor, reinforced by the leverage effect, can lead to the mounting threads being torn out.

## Type codes

<b>001</b>	<b>Series</b>	
<b>EPCO</b>	Electric cylinder, with spindle drive	

<b>002</b>	<b>Size</b>	
<b>16</b>	16	
<b>25</b>	25	
<b>40</b>	40	

<b>003</b>	<b>Stroke</b>	
<b>50</b>	50	
<b>75</b>	75	
<b>100</b>	100	
<b>125</b>	125	
<b>150</b>	150	
<b>175</b>	175	
<b>200</b>	200	
<b>250</b>	250	
<b>300</b>	300	
<b>350</b>	350	
<b>400</b>	400	

<b>004</b>	<b>Spindle pitch</b>	
<b>3P</b>	3 mm	
<b>5P</b>	5 mm	
<b>8P</b>	8 mm	
<b>10P</b>	10 mm	
<b>12.7P</b>	12.7 mm	

<b>005</b>	<b>Piston rod thread type</b>	
	Male thread	
<b>F</b>	Female thread	

<b>006</b>	<b>Piston rod extension</b>	
	None	
<b>...E</b>	1 ... 200 mm	

<b>007</b>	<b>Position sensing</b>	
	None	
<b>A</b>	For proximity sensor	

<b>008</b>	<b>Motor type</b>	
<b>ST</b>	Stepper motor ST	

<b>009</b>	<b>Measuring unit</b>	
	None	
<b>E</b>	Encoder	

<b>010</b>	<b>Brake</b>	
	None	
<b>B</b>	With brake	

<b>011</b>	<b>Cable outlet direction</b>	
	Standard	
<b>D</b>	Underneath	
<b>L</b>	Left	
<b>R</b>	Right	

<b>012</b>	<b>Guide unit</b>	
	None	
<b>KF</b>	Recirculating ball bearing with two guide rods	

<b>013</b>	<b>Connecting cable to motor controller</b>	
	None	
<b>1.5E</b>	1.5 m, suitable for energy chains, straight plug	
<b>2.5E</b>	2.5 m, suitable for energy chains, straight plug	
<b>5E</b>	5 m, suitable for energy chains, straight plug	
<b>7E</b>	7 m, suitable for energy chains, straight plug	
<b>10E</b>	10 m, suitable for energy chains, straight plug	
<b>1.5EA</b>	1.5 m, suitable for energy chains, angled plug	
<b>2.5EA</b>	2.5 m, suitable for energy chains, angled plug	
<b>5EA</b>	5 m, suitable for energy chains, angled plug	
<b>7EA</b>	7 m, suitable for energy chains, angled plug	
<b>10EA</b>	10 m, suitable for energy chains, angled plug	

<b>014</b>	<b>Controller type</b>	
	None	
<b>C5</b>	CMMO, 5 A	

<b>015</b>	<b>Bus protocol/activation</b>	
	None	
<b>DIO</b>	Digital I/O interface	
<b>LK</b>	IO-Link®	

<b>016</b>	<b>Switching input/output</b>	
	None	
<b>P</b>	PNP	
<b>N</b>	NPN	



Data sheet

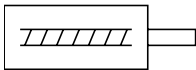

- - Size  
16 ... 40
- - Stroke length  
50 ... 400 mm
- - [www.festo.com](http://www.festo.com)



General technical data		16		25		40	
Size							
Design		Electric cylinder with ball screw and motor					
Piston rod thread							
Male thread		M6		M8		M10x1.25	
Female thread		M4		M6		M8	
Working stroke	[mm]	50 ... 200		50 ... 300		50 ... 400	
Stroke reserve	[mm]	0					
Max. angle of rotation at the piston rod	[°]	≤ ±2		≤ ±1.5		≤ ±1	
Impact energy in the end positions	[J]	0.1 x 10 <sup>-3</sup>		0.2 x 10 <sup>-3</sup>		0.4 x 10 <sup>-3</sup>	
Position sensing		Via proximity switch					
Type of mounting		With female thread					
		With accessories					
Mounting position		Any					

Mechanical data		16		25		40	
Size							
Spindle design		3P	8P	3P	10P	5P	12.7P
Spindle pitch <sup>1)</sup>	[mm/rev]	3	8	3	10	5	12.7
Spindle diameter	[mm]	8	8	10	10	12	12.7
Guide value for payload							
Horizontal <sup>2)</sup>	[kg]	24	8	60	20	120	40
Vertical	[kg]	12	4	30	10	60	20
Max. feed force F <sub>x</sub>	[N]	125	50	350	105	650	250
Max. speed	[mm/s]	125	300	150	500	180	460
Max. acceleration	[m/s <sup>2</sup> ]	10					
Reversing backlash <sup>3)</sup>	[mm]	≤ 0.1					
Repetition accuracy	[mm]	±0.02					

1) Nominal value varies due to component tolerances  
 2) Note max. transverse load  
 3) In new condition

## Data sheet

Electrical data		16	25	40
<b>Size</b>				
<b>Motor</b>				
Nominal voltage	[V DC]	24		
Nominal current	[A]	1.4	3	4.2
Holding torque	[Nm]	0.09	0.5	1.13
<b>Brake</b>				
Nominal voltage	[V DC]	24 ±10%		
Nominal power	[W]	8		
Holding torque	[Nm]	0.2	0.4	0.4
Mass moment of inertia	[kgmm <sup>2</sup> ]	1.8	8.2	29
<b>Encoder</b>				
Rotor position sensor		Incremental		
Rotor position sensor measuring principle		Optical		
Pulses/revolution	[1/rev]	500		
Interface		RS422, TTL, AB channel, zero index		
Operating voltage of encoder	[V DC]	5		
<b>Operating and environmental conditions</b>				
Ambient temperature <sup>1)</sup>	[°C]	0 ... +50		
Storage temperature	[°C]	-20 ... +60		
Relative humidity	[%]	0 ... 85 (non-condensing)		
Degree of protection to IEC 60529		IP40		
Corrosion resistance CRC <sup>2)</sup>		1		
Duty cycle	[%]	100		
CE marking (see declaration of conformity)		To EU EMC Directive <sup>3)</sup>		
UKCA marking (see declaration of conformity)		To UK instructions for EMC		
Certification		cUL us - Recognized (OL) RCM compliance mark		

1) Note operating range of proximity switches.

2) Corrosion resistance class CRC 1 to Festo standard FN 940070

Low corrosion stress. Dry internal application or transport and storage protection. Also applies to parts behind coverings, in the non-visible interior area, and parts which are covered in the application (e.g. drive trunnions).

3) For information about the area of use, see the EC declaration of conformity at: [www.festo.com/sp](http://www.festo.com/sp) → Certificates.

If the devices are subject to usage restrictions in residential, commercial or light-industrial environments, further measures for the reduction of the emitted interference may be necessary.

## Data sheet

<b>Weight [kg]</b>							
Size	16			25		40	
<b>Basic weight with 0 mm stroke</b>							
EPCO-...	0.62			1.04			2.49
EPCO-...-E	0.62			1.13			2.59
EPCO-...-B	0.68			1.22			2.71
EPCO-...-EB	0.68			1.28			2.77
EPCO-...-KF	1.22 ... 1.28			2.12 ... 2.36		4.40 ... 4.68	
<b>Additional weight per 100 mm stroke</b>							
EPCO-...	0.17			0.34			0.55
EPCO-...-KF	0.25			0.46			0.73
<b>Moving mass with 0 mm stroke</b>							
EPCO-...	0.07			0.15			0.42
EPCO-...-KF	0.23			0.45			0.98
<b>Moving mass per 100 mm stroke</b>							
EPCO-...	0.020			0.026			0.049
EPCO-...-KF	0.100			0.146			0.229
<b>Mass moments of inertia</b>							
Size	16			25		40	
Spindle design	3P	8P		3P	10P	5P	12.7P
<b>J<sub>0</sub> with 0 mm stroke</b>							
EPCO-...	[kg mm <sup>2</sup> ]	2.28	2.29	9.33	9.40	33.25	33.75
EPCO-...-B	[kg mm <sup>2</sup> ]	2.97	2.98	10.63	10.70	34.55	35.05
j <sub>S</sub> per meter stroke	[kg mm <sup>2</sup> /m]	2.53	2.65	4.87	5.78	11.66	16.70
j <sub>L</sub> per kg payload	[kg mm <sup>2</sup> /kg]	0.23	1.62	0.23	2.54	0.64	4.09

The mass moment of inertia  $J_A$  of the electric cylinder is calculated as follows:

$$J_A = J_0 + j_S \times \text{working stroke [m]} + j_L \times m_{\text{moving payload [kg]}}$$

## Data sheet

### Materials

Sectional view

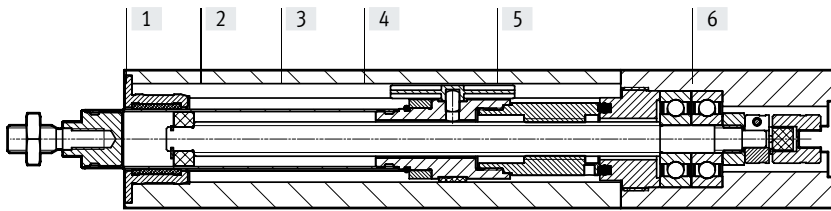

Electric cylinder

[1]	Bearing cap	Smooth-anodised wrought aluminium alloy
[2]	Cylinder barrel	Smooth-anodised wrought aluminium alloy
[3]	Piston rod	High-alloy stainless steel
[4]	Spindle	Rolled steel
[5]	Spindle nut	Steel
[6]	Drive cover	Wrought aluminium alloy
	Note on materials	RoHS-compliant
	PWIS conformity	VDMA24364 zone III

### Piston rod deflection $f$ as a function of projection $A$ and transverse load $F$

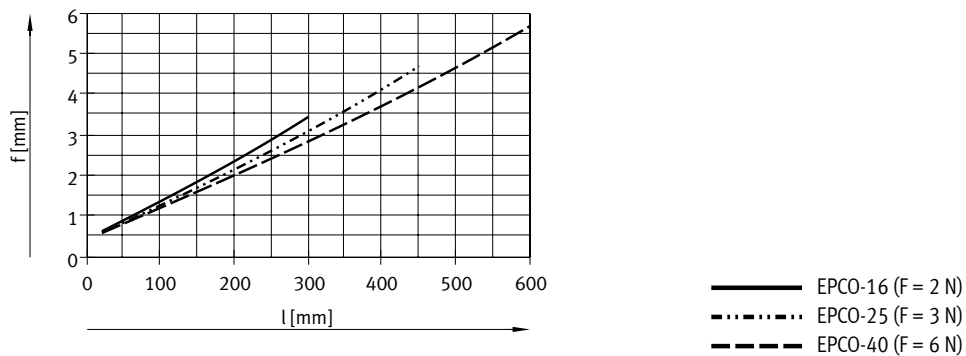
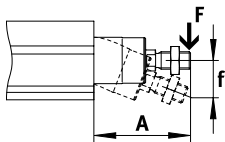

Data sheet

Maximum permissible loads on the piston rod

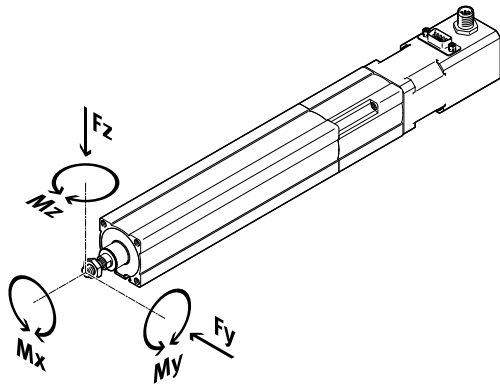

If there are several forces and torques simultaneously acting on the piston rod, the following equations must be satisfied:

$F_1/M_1$  = dynamic value

$F_2/M_2$  = maximum value

$$f_v = \frac{|F_{y1}|}{F_{y2}} + \frac{|F_{z1}|}{F_{z2}} + \frac{|M_{y1}|}{M_{y2}} + \frac{|M_{z1}|}{M_{z2}} \leq 1$$

$$|F_x| \leq F_{x_{max}}$$

$$|F_x| \leq F_{x_{max}}$$

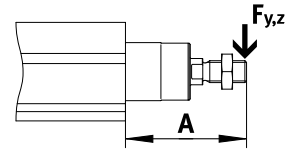

Maximum permissible transverse loads  $F_{y_{max}}$  and  $F_{z_{max}}$  on the piston rod as a function of projection A

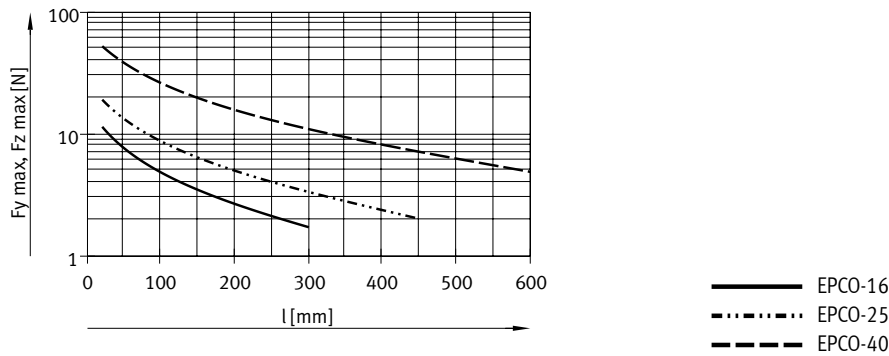

Size	16		25		40	
Spindle design	3P	8P	3P	10P	5P	12.7P
$F_{x_{max}}$ (static) [N]	125	50	350	105	650	250
$M_{x_{max}}$ [Nm]	0		0		0	
$M_{y_{max}}$ , $M_{z_{max}}$ [Nm]	0.6		1.0		3.3	

**Note**  
 Engineering software  
 Electric Motion Sizing  
 → [www.festo.com/x/electric-motion-sizing](http://www.festo.com/x/electric-motion-sizing)

Data sheet

Payload  $m$  as a function of speed  $v$  and acceleration  $a$

Horizontal mounting position

EPCO-16-3P

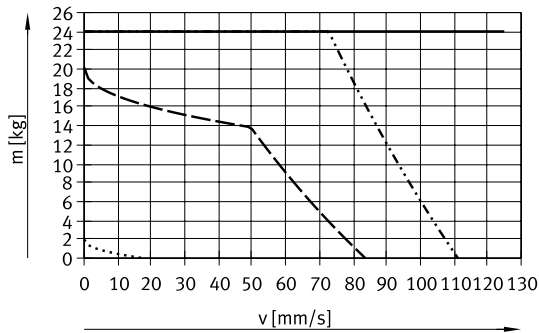

EPCO-16-8P

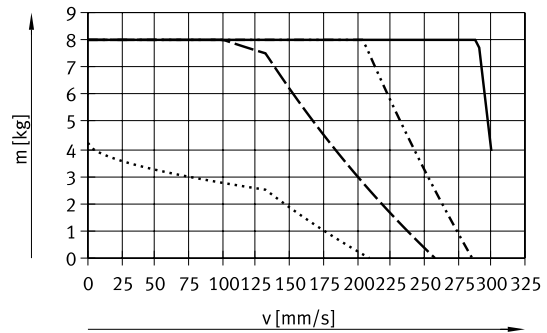

For EPCO-.../EPCO-...-KF

- $a = 0.5 \text{ m/s}^2$
- .....  $a = 2.5 \text{ m/s}^2$
- - -  $a = 5 \text{ m/s}^2$
- · - ·  $a = 10 \text{ m/s}^2$

EPCO-25-3P

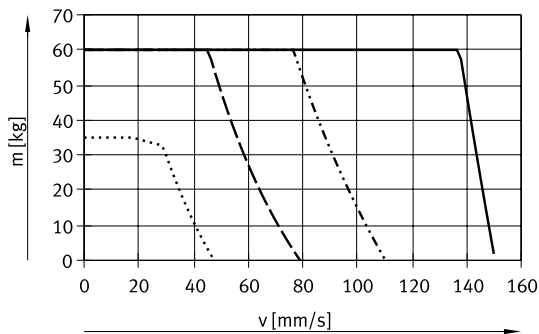

EPCO-25-10P

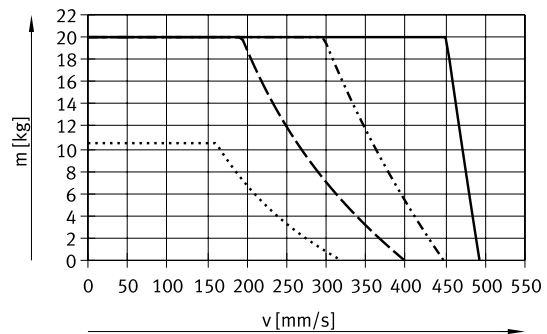

For EPCO-.../EPCO-...-KF

- $a = 0.5 \text{ m/s}^2$
- .....  $a = 2.5 \text{ m/s}^2$
- - -  $a = 5 \text{ m/s}^2$
- · - ·  $a = 10 \text{ m/s}^2$

EPCO-40-5P

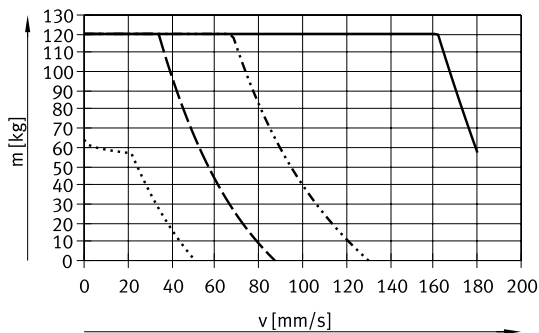

EPCO-40-12.7P

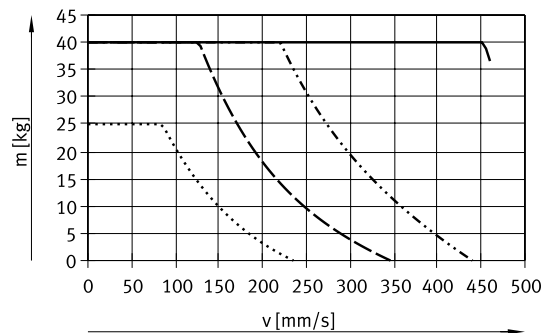

For EPCO-.../EPCO-...-KF

- $a = 0.5 \text{ m/s}^2$
- .....  $a = 2.5 \text{ m/s}^2$
- - -  $a = 5 \text{ m/s}^2$
- · - ·  $a = 10 \text{ m/s}^2$

## Data sheet

### Payload $m$ as a function of speed $v$ and acceleration $a$

Vertical mounting position

The moving net mass of the guide unit (EPCO-...-KF) results in lower acceleration values with identical payload/speed.

EPCO-16-3P

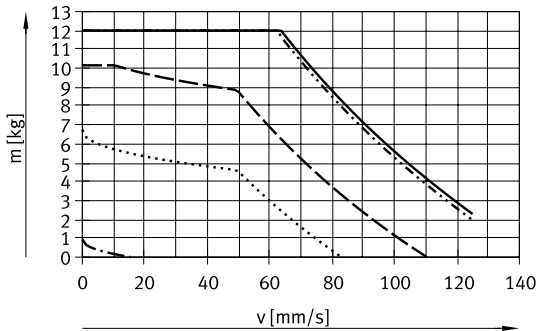

For EPCO-...

- $a = 0 \text{ m/s}^2$
- .....  $a = 0.2 \text{ m/s}^2$
- - -  $a = 2.5 \text{ m/s}^2$
- .....  $a = 5 \text{ m/s}^2$
- · - · -  $a = 10 \text{ m/s}^2$

For EPCO-...-KF

- $a = 0 \text{ m/s}^2$
- $a = 2.3 \text{ m/s}^2$
- $a = 4.7 \text{ m/s}^2$
- $a = 9.6 \text{ m/s}^2$

EPCO-16-8P

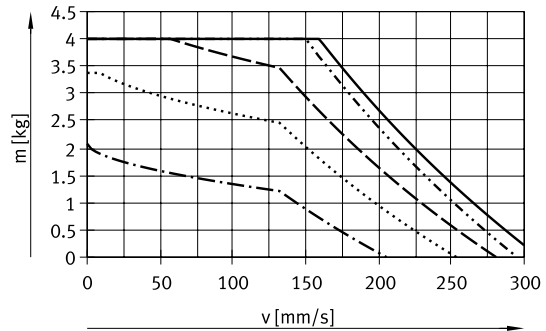

For EPCO-...

- $a = 0 \text{ m/s}^2$
- .....  $a = 1.2 \text{ m/s}^2$
- - -  $a = 2.5 \text{ m/s}^2$
- .....  $a = 5 \text{ m/s}^2$
- · - · -  $a = 10 \text{ m/s}^2$

For EPCO-...-KF

- $a = 0 \text{ m/s}^2$
- $a = 1.2 \text{ m/s}^2$
- $a = 3.4 \text{ m/s}^2$
- $a = 7.8 \text{ m/s}^2$

EPCO-25-3P

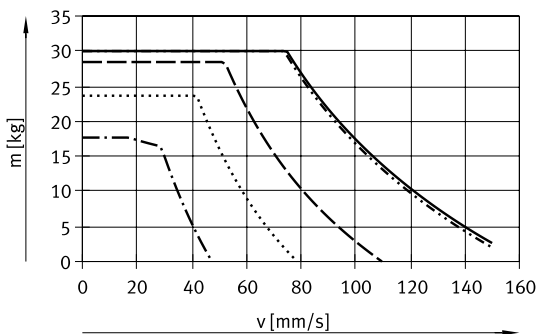

For EPCO-...

- $a = 0 \text{ m/s}^2$
- .....  $a = 0.2 \text{ m/s}^2$
- - -  $a = 2.5 \text{ m/s}^2$
- .....  $a = 5 \text{ m/s}^2$
- · - · -  $a = 10 \text{ m/s}^2$

For EPCO-...-KF

- $a = 0 \text{ m/s}^2$
- $a = 2.4 \text{ m/s}^2$
- $a = 4.9 \text{ m/s}^2$
- $a = 9.8 \text{ m/s}^2$

Further technical data for the guide unit EAGF-P1

→ [www.festo.com/eagf-p1](http://www.festo.com/eagf-p1)

EPCO-25-10P

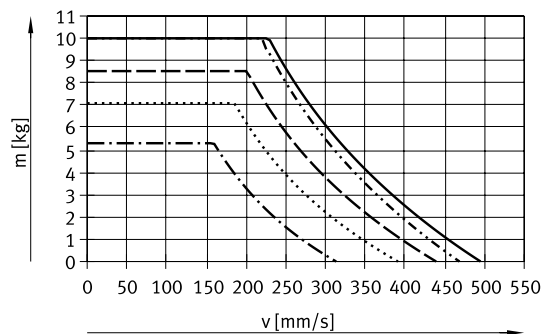

For EPCO-...

- $a = 0 \text{ m/s}^2$
- .....  $a = 1.2 \text{ m/s}^2$
- - -  $a = 2.5 \text{ m/s}^2$
- .....  $a = 5 \text{ m/s}^2$
- · - · -  $a = 10 \text{ m/s}^2$

For EPCO-...-KF

- $a = 0 \text{ m/s}^2$
- $a = 1.6 \text{ m/s}^2$
- $a = 3.9 \text{ m/s}^2$
- $a = 8.3 \text{ m/s}^2$

## Data sheet

### Payload $m$ as a function of speed $v$ and acceleration $a$

Vertical mounting position

The moving net mass of the guide unit (EPCO-...-KF) results in lower acceleration values with identical payload/speed.

EPCO-40-5P

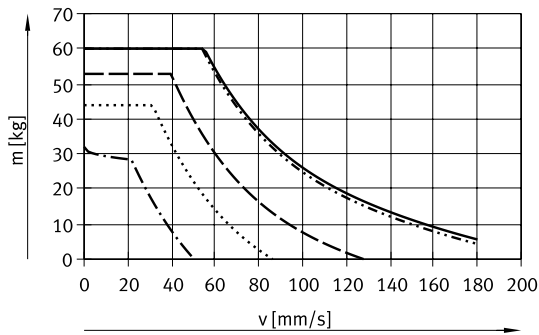

For EPCO-...

- $a = 0 \text{ m/s}^2$
- .....  $a = 0.2 \text{ m/s}^2$
- - -  $a = 2.5 \text{ m/s}^2$
- · - · -  $a = 5 \text{ m/s}^2$
- - - - -  $a = 10 \text{ m/s}^2$

For EPCO-...-KF

- $a = 0 \text{ m/s}^2$
- $a = 2.4 \text{ m/s}^2$
- $a = 4.8 \text{ m/s}^2$
- $a = 9.7 \text{ m/s}^2$

EPCO-40-12.7P

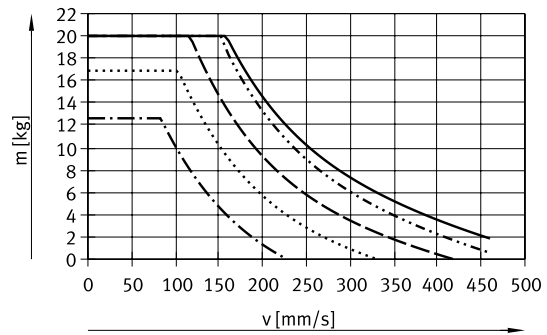

For EPCO-...

- $a = 0 \text{ m/s}^2$
- .....  $a = 1.2 \text{ m/s}^2$
- - -  $a = 2.5 \text{ m/s}^2$
- · - · -  $a = 5 \text{ m/s}^2$
- - - - -  $a = 10 \text{ m/s}^2$

For EPCO-...-KF

- $a = 0 \text{ m/s}^2$
- $a = 1.8 \text{ m/s}^2$
- $a = 4.0 \text{ m/s}^2$
- $a = 8.5 \text{ m/s}^2$

### Payload $m$ as a function of travel distance $l$ and positioning time $t$

Horizontal mounting position

The moving net mass of the guide unit (EPCO-...-KF) results in longer positioning times with identical payload/travel distance.

EPCO-16-3P

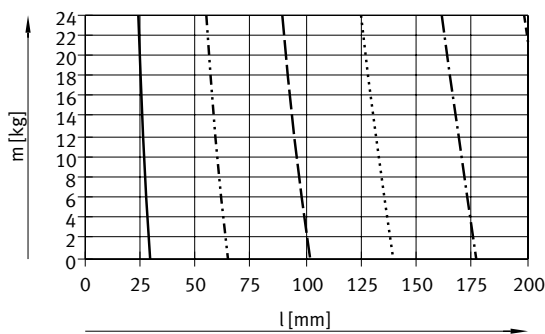

For EPCO-...

- $t = 0.30 \text{ s}$
- .....  $t = 0.60 \text{ s}$
- - -  $t = 0.90 \text{ s}$
- · - · -  $t = 1.20 \text{ s}$
- - - - -  $t = 1.50 \text{ s}$
- - - - -  $t = 1.80 \text{ s}$

For EPCO-...-KF

- $t = 0.30 \text{ s}$
- $t = 0.60 \text{ s}$
- $t = 0.90 \text{ s}$
- $t = 1.20 \text{ s}$
- $t = 1.55 \text{ s}$
- $t = 1.85 \text{ s}$

EPCO-16-8P

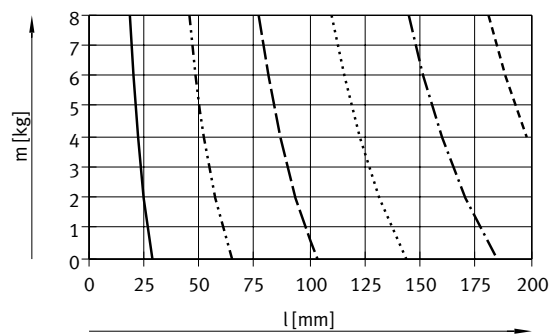

For EPCO-...

- $t = 0.15 \text{ s}$
- .....  $t = 0.30 \text{ s}$
- - -  $t = 0.45 \text{ s}$
- · - · -  $t = 0.60 \text{ s}$
- - - - -  $t = 0.75 \text{ s}$
- - - - -  $t = 0.90 \text{ s}$

For EPCO-...-KF

- $t = 0.15 \text{ s}$
- $t = 0.30 \text{ s}$
- $t = 0.45 \text{ s}$
- $t = 0.65 \text{ s}$
- $t = 0.80 \text{ s}$
- $t = 0.95 \text{ s}$

Further technical data for the guide unit EAGF-P1

→ [www.festo.com/eagf-p1](http://www.festo.com/eagf-p1)



## Data sheet

### Payload $m$ as a function of travel distance $l$ and positioning time $t$

Horizontal mounting position

The moving net mass of the guide unit (EPCO-...-KF) results in longer positioning times with identical payload/travel distance.

#### EPCO-25-3P

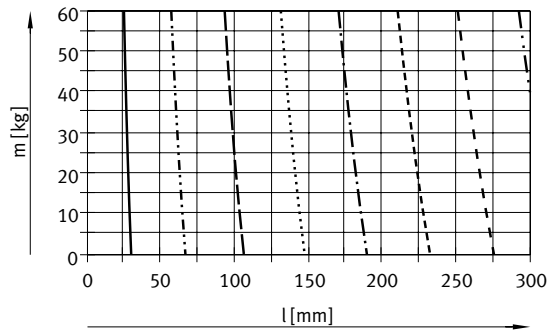

For EPCO-...

- $t = 0.30$  s
- ⋯  $t = 0.60$  s
- - -  $t = 0.90$  s
- ⋯⋯  $t = 1.20$  s
- · - ·  $t = 1.50$  s
- - - -  $t = 1.80$  s
- - - -  $t = 2.10$  s
- · - ·  $t = 2.40$  s

For EPCO-...-KF

- $t = 0.30$  s
- $t = 0.60$  s
- $t = 0.90$  s
- $t = 1.20$  s
- $t = 1.50$  s
- $t = 1.80$  s
- $t = 2.10$  s
- $t = 2.40$  s

#### EPCO-25-10P

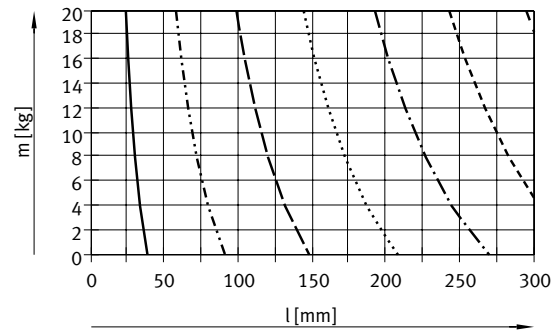

For EPCO-...

- $t = 0.15$  s
- ⋯  $t = 0.30$  s
- - -  $t = 0.45$  s
- ⋯⋯  $t = 0.60$  s
- · - ·  $t = 0.75$  s
- - - -  $t = 0.90$  s
- - - -  $t = 1.05$  s

For EPCO-...-KF

- $t = 0.15$  s
- $t = 0.30$  s
- $t = 0.45$  s
- $t = 0.60$  s
- $t = 0.80$  s
- $t = 0.95$  s
- $t = 1.10$  s

#### EPCO-40-5P

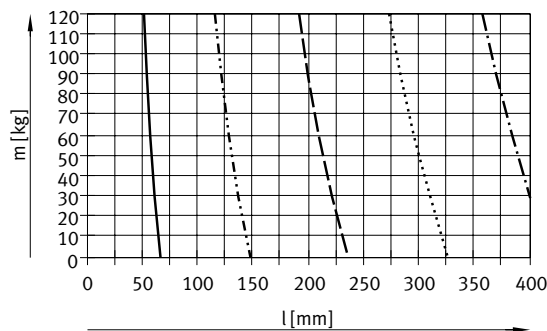

For EPCO-...

- $t = 0.50$  s
- ⋯  $t = 1.00$  s
- - -  $t = 1.50$  s
- ⋯⋯  $t = 2.00$  s
- · - ·  $t = 2.50$  s

For EPCO-...-KF

- $t = 0.50$  s
- $t = 1.00$  s
- $t = 1.55$  s
- $t = 2.05$  s
- $t = 2.55$  s

#### EPCO-40-12.7P

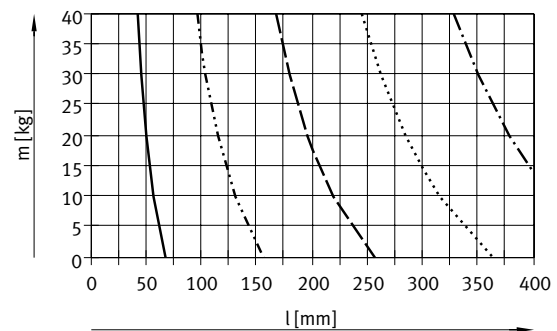

For EPCO-...

- $t = 0.25$  s
- ⋯  $t = 0.50$  s
- - -  $t = 0.75$  s
- ⋯⋯  $t = 1.00$  s
- · - ·  $t = 1.25$  s

For EPCO-...-KF

- $t = 0.25$  s
- $t = 0.50$  s
- $t = 0.80$  s
- $t = 1.05$  s
- $t = 1.30$  s

Further technical data for the guide unit EAGF-P1

→ [www.festo.com/eagf-p1](http://www.festo.com/eagf-p1)

## Data sheet

### Payload $m$ as a function of travel distance $l$ and positioning time $t$

Vertical mounting position

The moving net mass of the guide unit (EPCO-...-KF) results in longer positioning times with identical payload/travel distance.

#### EPCO-16-3P

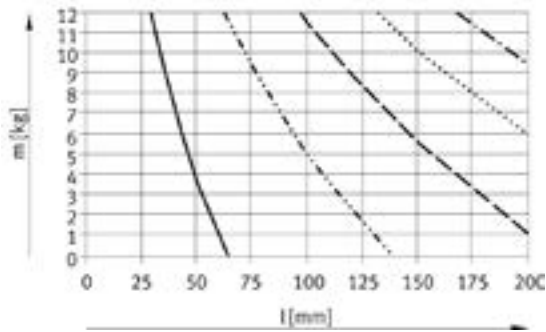

For EPCO-...

- $t = 0.60$  s
- · - · -  $t = 1.20$  s
- - -  $t = 1.80$  s
- · · · ·  $t = 2.40$  s
- · - · -  $t = 3.00$  s

For EPCO-...-KF

- $t = 0.60$  s
- $t = 1.25$  s
- $t = 1.85$  s
- $t = 2.50$  s
- $t = 3.10$  s

#### EPCO-16-8P

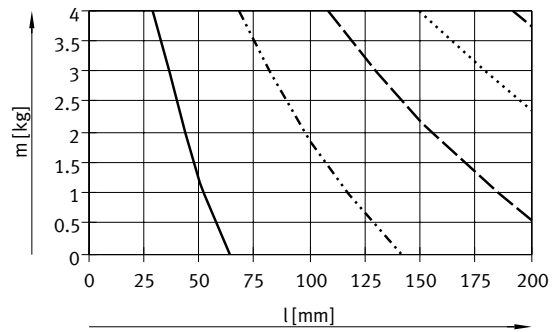

For EPCO-...

- $t = 0.30$  s
- · - · -  $t = 0.60$  s
- - -  $t = 0.90$  s
- · · · ·  $t = 1.20$  s
- · - · -  $t = 1.50$  s

For EPCO-...-KF

- $t = 0.35$  s
- $t = 0.65$  s
- $t = 1.00$  s
- $t = 1.30$  s
- $t = 1.65$  s

#### EPCO-25-3P

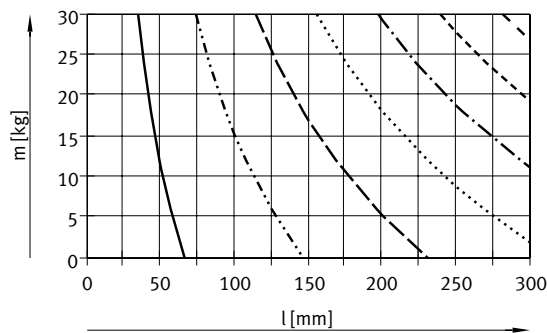

For EPCO-...

- $t = 0.60$  s
- · - · -  $t = 1.20$  s
- - -  $t = 1.80$  s
- · · · ·  $t = 2.40$  s
- · - · -  $t = 3.00$  s
- - -  $t = 3.60$  s
- - -  $t = 4.20$  s

For EPCO-...-KF

- $t = 0.60$  s
- $t = 1.20$  s
- $t = 1.85$  s
- $t = 2.45$  s
- $t = 3.05$  s
- $t = 3.70$  s
- $t = 4.30$  s

#### EPCO-25-10P

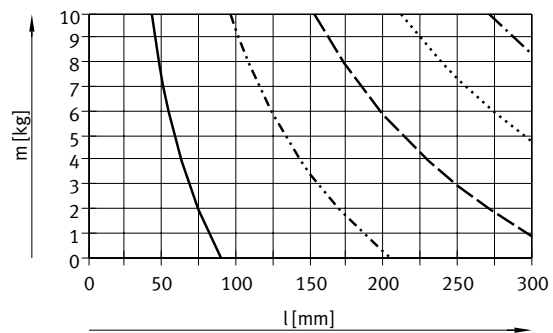

For EPCO-...

- $t = 0.30$  s
- · - · -  $t = 0.60$  s
- - -  $t = 0.90$  s
- · · · ·  $t = 1.20$  s
- · - · -  $t = 1.50$  s

For EPCO-...-KF

- $t = 0.30$  s
- $t = 0.65$  s
- $t = 0.95$  s
- $t = 1.25$  s
- $t = 1.60$  s

Further technical data for the guide unit EAGF-P1

→ [www.festo.com/eagf-p1](http://www.festo.com/eagf-p1)

## Data sheet

### Payload $m$ as a function of travel distance $l$ and positioning time $t$

Vertical mounting position

The moving net mass of the guide unit (EPCO-...-KF) results in longer positioning times with identical payload/travel distance.

#### EPCO-40-5P

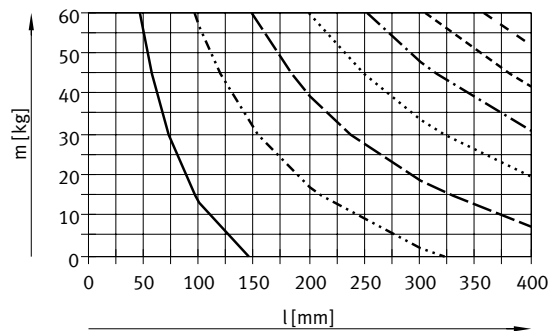

For EPCO-...

- $t = 1.00$  s
- · - · -  $t = 2.00$  s
- - -  $t = 3.00$  s
- · · · ·  $t = 4.00$  s
- · - · -  $t = 5.00$  s
- - -  $t = 6.00$  s
- - -  $t = 7.00$  s

For EPCO-...-KF

- $t = 1.05$  s
- $t = 2.05$  s
- $t = 3.10$  s
- $t = 4.10$  s
- $t = 5.15$  s
- $t = 6.20$  s
- $t = 7.20$  s

#### EPCO-40-12.7P

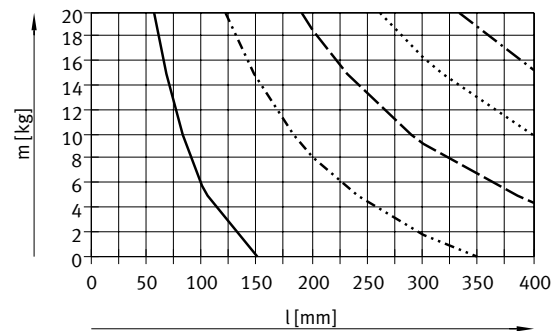

For EPCO-...

- $t = 0.55$  s
- · - · -  $t = 1.00$  s
- - -  $t = 1.50$  s
- · · · ·  $t = 2.00$  s
- · - · -  $t = 2.50$  s

For EPCO-...-KF

- $t = 0.55$  s
- $t = 1.10$  s
- $t = 1.60$  s
- $t = 2.15$  s
- $t = 2.70$  s

### Feed force $F$ as a function of speed $v$ and acceleration $a$

The moving net mass of the guide unit (EPCO-...-KF) results in lower acceleration values with identical feed force/speed.

#### EPCO-16-3P

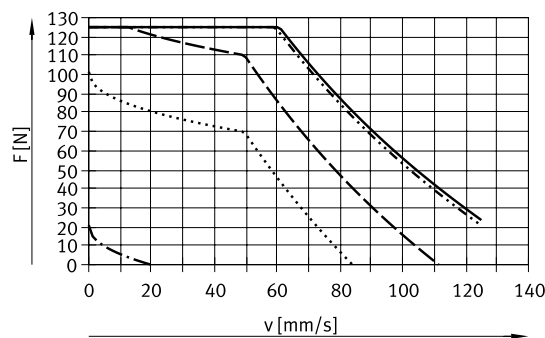

For EPCO-...

- $a = 0$  m/s<sup>2</sup>
- · - · -  $a = 0.2$  m/s<sup>2</sup>
- - -  $a = 2.5$  m/s<sup>2</sup>
- · · · ·  $a = 5$  m/s<sup>2</sup>
- · - · -  $a = 10$  m/s<sup>2</sup>

For EPCO-...-KF

- $a = 0$  m/s<sup>2</sup>
- $a = 2.3$  m/s<sup>2</sup>
- $a = 4.7$  m/s<sup>2</sup>
- $a = 9.6$  m/s<sup>2</sup>

#### EPCO-16-8P

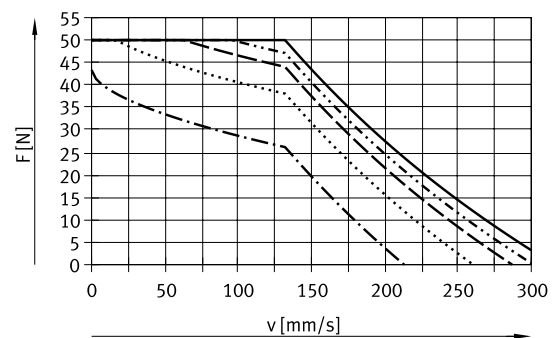

For EPCO-...

- $a = 0$  m/s<sup>2</sup>
- · - · -  $a = 1.2$  m/s<sup>2</sup>
- - -  $a = 2.5$  m/s<sup>2</sup>
- · · · ·  $a = 5$  m/s<sup>2</sup>
- · - · -  $a = 10$  m/s<sup>2</sup>

For EPCO-...-KF

- $a = 0$  m/s<sup>2</sup>
- $a = 1.2$  m/s<sup>2</sup>
- $a = 3.4$  m/s<sup>2</sup>
- $a = 7.8$  m/s<sup>2</sup>

Further technical data for the guide unit EAGF-P1

→ [www.festo.com/eagf-p1](http://www.festo.com/eagf-p1)

Data sheet

Feed force F as a function of speed v and acceleration a

The moving net mass of the guide unit (EPCO-...-KF) results in lower acceleration values with identical feed force/speed.

EPCO-25-3P

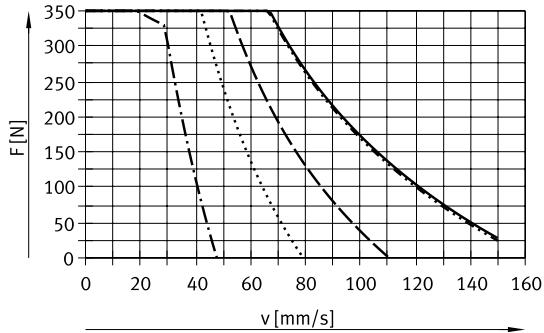

For EPCO-...

- a = 0 m/s<sup>2</sup>
- a = 0.2 m/s<sup>2</sup>
- - - a = 2.5 m/s<sup>2</sup>
- · - · a = 5 m/s<sup>2</sup>
- - - - a = 10 m/s<sup>2</sup>

For EPCO-...-KF

- a = 0 m/s<sup>2</sup>
- a = 2.4 m/s<sup>2</sup>
- a = 4.9 m/s<sup>2</sup>
- a = 9.8 m/s<sup>2</sup>

EPCO-25-10P

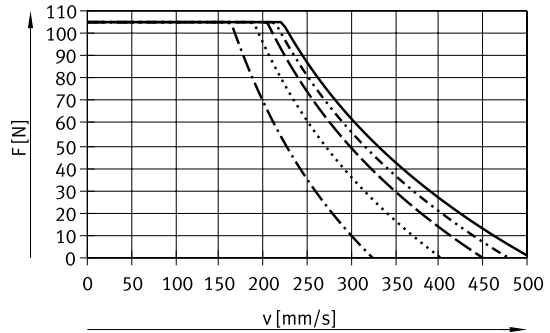

For EPCO-...

- a = 0 m/s<sup>2</sup>
- a = 1.2 m/s<sup>2</sup>
- - - a = 2.5 m/s<sup>2</sup>
- · - · a = 5 m/s<sup>2</sup>
- - - - a = 10 m/s<sup>2</sup>

For EPCO-...-KF

- a = 0 m/s<sup>2</sup>
- a = 1.6 m/s<sup>2</sup>
- a = 3.9 m/s<sup>2</sup>
- a = 8.3 m/s<sup>2</sup>

EPCO-40-5P

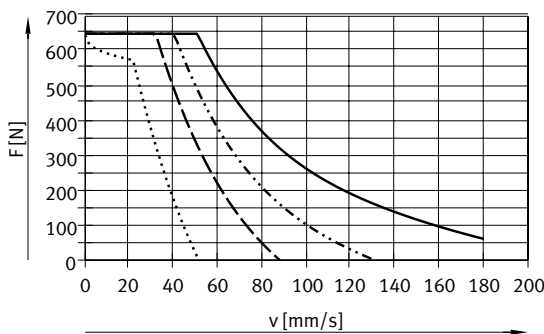

For EPCO-...

- a = 0 m/s<sup>2</sup>
- a = 0.2 m/s<sup>2</sup>
- - - a = 2.5 m/s<sup>2</sup>
- · - · a = 5 m/s<sup>2</sup>
- - - - a = 10 m/s<sup>2</sup>

For EPCO-...-KF

- a = 0 m/s<sup>2</sup>
- a = 2.4 m/s<sup>2</sup>
- a = 4.8 m/s<sup>2</sup>
- a = 9.7 m/s<sup>2</sup>

EPCO-40-12.7P

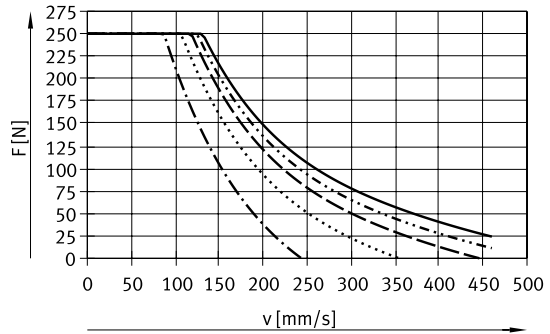

For EPCO-...

- a = 0 m/s<sup>2</sup>
- a = 1.2 m/s<sup>2</sup>
- - - a = 2.5 m/s<sup>2</sup>
- · - · a = 5 m/s<sup>2</sup>
- - - - a = 10 m/s<sup>2</sup>

For EPCO-...-KF

- a = 0 m/s<sup>2</sup>
- a = 1.8 m/s<sup>2</sup>
- a = 4.0 m/s<sup>2</sup>
- a = 8.5 m/s<sup>2</sup>

Further technical data for the guide unit EAGF-P1

→ [www.festo.com/eagf-p1](http://www.festo.com/eagf-p1)

## Data sheet

### Calculating the mean feed force $F_{xm}$ with the electric cylinder EPCO

The peak feed force value must not exceed the maximum feed force within a movement cycle. The peak value is generally achieved in vertical operation during the acceleration phase of the upwards stroke. If the maximum feed force is exceeded, this can increase wear and thus shorten the service life of the ball screw. The maximum speed must likewise not be exceeded:

$$F_x \leq F_{x\max.}$$

and

$$v_x \leq v_{x\max.}$$

#### Mean feed force (to DIN 69051-4)

During operation, the continuous feed force may be briefly exceeded up to the maximum feed force. The continuous feed force must, however, be adhered to when averaged over a movement cycle:

$$F_{xm} \leq F_{x\text{continuous}}$$

$$F_{xm} = \sqrt[3]{\sum F_x^3 \cdot \frac{v_x}{v_{xm}} \cdot \frac{q}{100}} =$$

$$F_{xm} = \sqrt[3]{F_{x1}^3 \cdot \frac{v_{x1}}{v_{xm}} \cdot \frac{q_1}{100} + F_{x2}^3 \cdot \frac{v_{x2}}{v_{xm}} \cdot \frac{q_2}{100} + F_{x3}^3 \cdot \frac{v_{x3}}{v_{xm}} \cdot \frac{q_3}{100} + \dots}$$

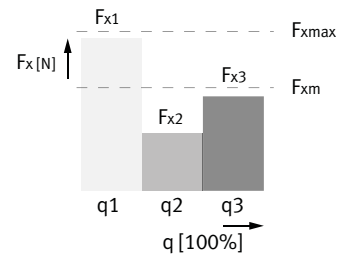

#### Mean feed speed (to DIN 69051-4)

$$v_{xm} = \sum v_x \cdot \frac{q}{100} = v_{x1} \cdot \frac{q_1}{100} + v_{x2} \cdot \frac{q_2}{100} + v_{x3} \cdot \frac{q_3}{100} + \dots$$

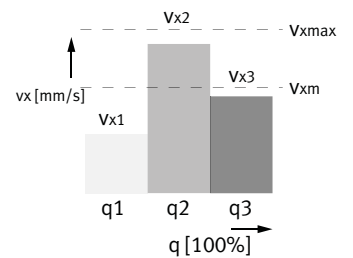

$F_x$	Feed force	$v_x$	Feed speed
$F_{xm}$	Mean feed force	$v_{xm}$	Mean feed speed
$F_{x\max.}$	Max. feed force	$v_x$	Max. feed speed
$F_{x\text{continuous}}$	Continuous feed force		

Data sheet

Mean feed force F as a function of running performance L (to DIN 69051-4)

EPCO-16

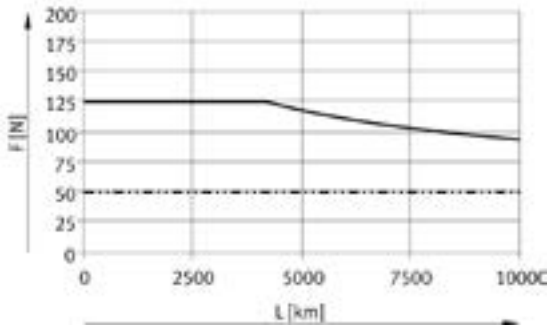

EPCO-25

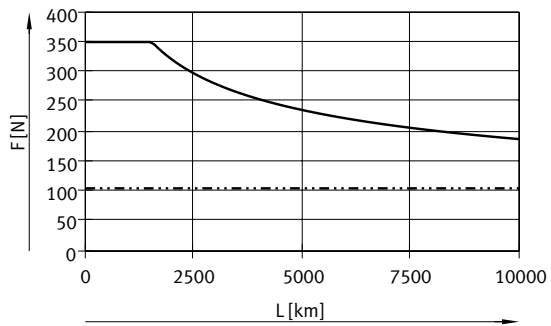

— EPCO-16-3P  
- - - EPCO-16-8P

— EPCO-25-3P  
- - - EPCO-25-10P

EPCO-40

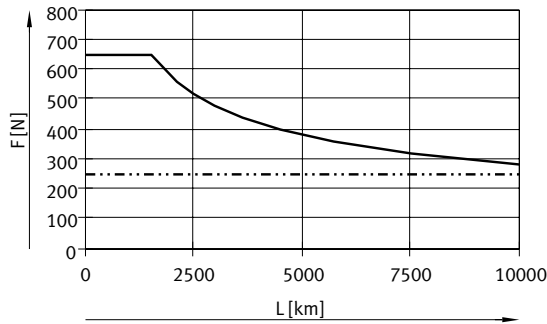

— EPCO-40-5P  
- - - EPCO-40-12.7P

**Note**  
The specifications for running performance are based on experimentally determined and theoretically calculated data. The running performance that can be achieved in practice can deviate considerably from the specified curves under different parameters.

Pin allocation

Motor

Encoder

EPCO-16

EPCO-25/-40

EPCO-16/-25/-40

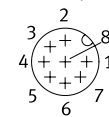
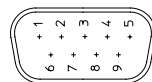
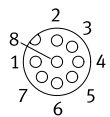

PIN	Function
1	String A
2	String A/
3	String B
4	String B/
5	n.c.
6	n.c.
7	Brake +24 V DC <sup>1)</sup>
8	Brake GND <sup>1)</sup>
-	-

PIN	Function
1	String A
2	String A/
3	String B
4	String B/
5	n.c.
6	n.c.
7	Brake +24 V DC <sup>1)</sup>
8	Brake GND <sup>1)</sup>
9	n.c.

PIN	Function
1	Signal trace A
2	Signal trace A/
3	Signal trace B
4	Signal trace B/
5	Encoder GND
6	Signal trace N
7	Signal trace N/
8	VCC auxiliary supply +5 V
GND	Shielding on plug housing

1) Only on motors with brake.

Data sheet

Dimensions

Download CAD data → [www.festo.com](http://www.festo.com)

Size 16

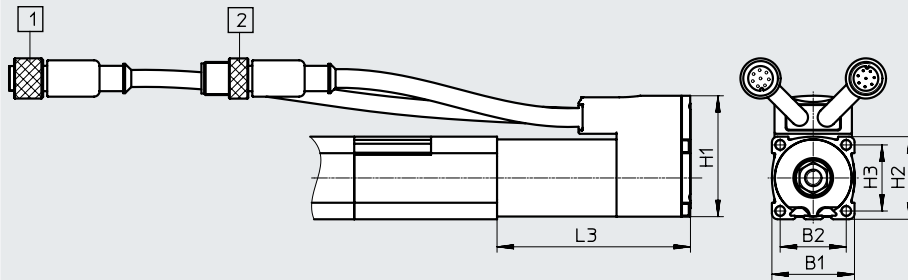

- [1] Motor connection: round plug M12, 8-pin, bushing (cable length: 350 mm)
- [2] Encoder connection: round plug M12, 8-pin, pins (cable length: 250 mm)
- [3] Min. bending radius of the cables: 60 mm

Size 25, 40

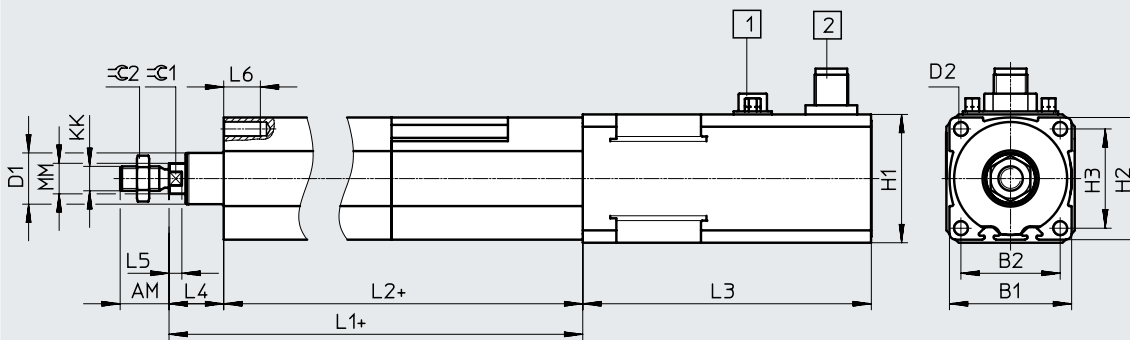

- [1] Motor connection: SUB-D plug, 9-pin, pins
- [2] Encoder connection: round plug M12, 8-pin, pins
- + plus stroke length

Size	AM	B1	B2	D1 ∅ ±0.05	D2 ∅	H1	H2	H3	KK	L1	L2 ±1	
16	-0.5	12	30	24	13.27	M4	44	30	24	M6	143	127
25	16	40	32.5	17.27	M5	42 <sup>+0.3</sup>	40	32.5	M8	174.6	156.6	
40	19	55	42	26.52	M6	56.4	55	42	M10x1.25	214.2	192.7	

Size	L3				L4	L5	L6	MM	⌀1	⌀2
	EPCO-...	-E	-B	-EB						
16	70±1	70±1	96±1.5	96±1.5	16	3.7	10	8	7	10
25	66±1	94.4±1.2	114.4±1.3	127.4±1.3	18	4.2	12	10	9	13
40	73.5±0.8	102.5±1.1	123.5±1.1	138±1.1	21.5	4.7	14	12	10	17

## Data sheet

### Dimensions

Download CAD data → [www.festo.com](http://www.festo.com)

#### Variants

E – Extended piston rod

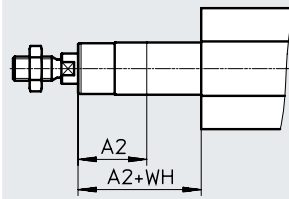

F – Female piston rod thread

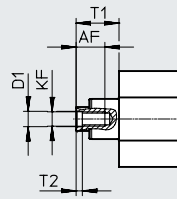

Size	A2 max.	AF	KF	T1	T2	D1	WH
16	100	10	M4	16	1.5	4.3	16
25	150	12	M6	18	2.6	6.4	18
40	200	14	M8	21.5	3.3	8.4	21.5



## Data sheet

Ordering data – EPCO-16			Ordering data – EPCO-16		
Stroke [mm]	Part no.	Type	Stroke [mm]	Part no.	Type
<b>Spindle pitch 3 mm/rev, with encoder</b>			<b>Spindle pitch 8 mm/rev, with encoder</b>		
50	1476415	EPCO-16-50-3P-ST-E	50	1476522	EPCO-16-50-8P-ST-E
100	1476417	EPCO-16-100-3P-ST-E	100	1476524	EPCO-16-100-8P-ST-E
150	1476419	EPCO-16-150-3P-ST-E	150	1476526	EPCO-16-150-8P-ST-E
200	1476421	EPCO-16-200-3P-ST-E	200	1476528	EPCO-16-200-8P-ST-E

Ordering data – EPCO-25			Ordering data – EPCO-25		
Stroke [mm]	Part no.	Type	Stroke [mm]	Part no.	Type
<b>Spindle pitch 3 mm/rev, with encoder</b>			<b>Spindle pitch 10 mm/rev, with encoder</b>		
50	1470698	EPCO-25-50-3P-ST-E	50	1470769	EPCO-25-50-10P-ST-E
100	1470700	EPCO-25-100-3P-ST-E	100	1470771	EPCO-25-100-10P-ST-E
150	1470702	EPCO-25-150-3P-ST-E	150	1470773	EPCO-25-150-10P-ST-E
200	1470704	EPCO-25-200-3P-ST-E	200	1470775	EPCO-25-200-10P-ST-E
300	1470706	EPCO-25-300-3P-ST-E	300	1470777	EPCO-25-300-10P-ST-E

Ordering data – EPCO-40			Ordering data – EPCO-40		
Stroke [mm]	Part no.	Type	Stroke [mm]	Part no.	Type
<b>Spindle pitch 5 mm/rev, with encoder</b>			<b>Spindle pitch 12.7 mm/rev, with encoder</b>		
50	1472501	EPCO-40-50-5P-ST-E	50	1472617	EPCO-40-50-12.7P-ST-E
100	1472503	EPCO-40-100-5P-ST-E	100	1472619	EPCO-40-100-12.7P-ST-E
150	1472505	EPCO-40-150-5P-ST-E	150	1472621	EPCO-40-150-12.7P-ST-E
200	1472507	EPCO-40-200-5P-ST-E	200	1472623	EPCO-40-200-12.7P-ST-E
300	1472509	EPCO-40-300-5P-ST-E	300	1472625	EPCO-40-300-12.7P-ST-E

 **Note**

Variants ordered via modular product system → page 26

 **Note**

Position sensing is only possible in combination with characteristic "A"  
→ page 26 (modular product system)

Ordering data – Modular product system

Ordering table							
Size	16	25	40	Conditions	Code	Enter code	
Module no.	<b>1476585</b>	<b>1470874</b>	<b>1472887</b>				
Function	Electric cylinder				<b>EPCO</b>	EPCO	
Size	16	25	40		-...		
Stroke [mm]	50				-...		
	75				-...		
	100				-...		
	125				-...		
	150				-...		
	175				-...		
	200				-...		
	-		250			-...	
	-		300			-...	
	-			350		-...	
	-			400		-...	
	Spindle pitch	3	3			-...P	
-		-	5				
8		-	-				
-		10	-				
-		-	12.7				
Piston rod thread type	Male thread						
	Female thread				-F		
Piston rod extension [mm]	Without						
	1 ... 100	1 ... 150	1 ... 200		-...E		
Position sensing	Without						
	Via proximity switch			[1]	-A		
Motor type	Stepper motor				-ST	ST	

[1] **A** Must be selected if encoder E is not selected.

## Ordering data – Modular product system

Ordering table		16	25	40	Conditions	Code	Enter code
Size							
Measuring unit	Without						
	Encoder					-E	
Brake	Without						
	Brake					B	
Cable outlet direction	Top (standard)						
	Underneath					-D	
	Left					-L	
	Right					-R	
Guide unit	Without						
	Recirculating ball bearing guide with 2 guide rods				[2]	-KF	
Connecting cable to motor controller, suitable for energy chains	Without						
	1.5 m, straight plug					+1.5E	
	1.5 m, angled plug				[3]	+1.5EA	
	2.5 m, straight plug				[3]	+2.5E	
	2.5 m, angled plug				[3]	+2.5EA	
	5 m, straight plug				[3]	+5E	
	5 m, angled plug				[3]	+5EA	
	7 m, straight plug				[3]	+7E	
	7 m, angled plug				[3]	+7EA	
	10 m, straight plug				[3]	+10E	
10 m, angled plug				[3]	+10EA		
Controller type	Without						
	CMMO, 5 A					+C5	
Bus protocol/control	Without						
	Digital I/O interface				[4]	DIO	
	IO-Link				[4]	LK	
Switching input/output	Without						
	NPN				[4] [5]	N	
	PNP				[4]	P	

[2] **KF** Not with piston rod extension ...E

[3] **1.5E, 1.5EA, 2.5E, 2.5EA, 5E, 5EA, 7E, 7EA, 10E, 10EA, C5** Only with encoder E

[4] **DIO, LK, N, P** Must be selected if controller type +C5 is selected

[5] **N** Not with IO-Link LK

## Accessories

### Foot mounting EAHF

Material:  
Galvanised steel  
RoHS-compliant

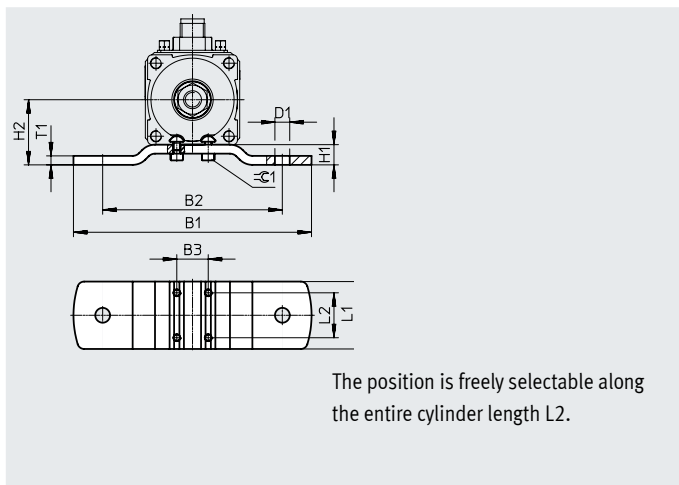

#### Dimensions and ordering data

For size	B1	B2	B3	D1 ∅	H1	H2	L1
16	86	60	10	5.5	7	22	30
25	106	80	14	6.6	9	29	30
40	130	100	18	9	10.5	38	40

For size	L2	T1	⊕C1	CRC <sup>1)</sup>	Weight [g]	Part no.	Type
16	20	3	2.5	1	60	1434903	EAHF-P1-16
25	20	4	2.5	1	100	1434904	EAHF-P1-25
40	20	4	4	1	160	1434905	EAHF-P1-40

1) Corrosion resistance class CRC 1 to Festo standard FN 940070

Low corrosion stress. Dry internal application or transport and storage protection. Also applies to parts behind coverings, in the non-visible interior area, and parts which are covered in the application (e.g. drive trunnions).

## Accessories

### Flange mounting EAHH

Material:  
Galvanised steel  
RoHS-compliant

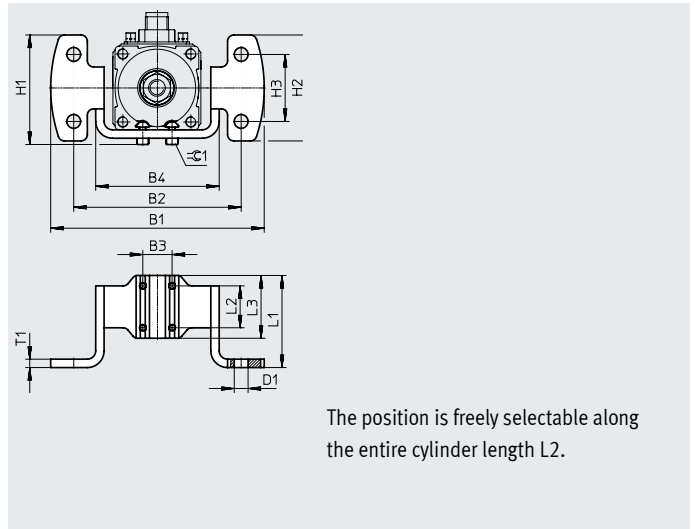

Dimensions and ordering data									
For size	B1	B2	B3	B4	D1 ∅	H1	H2	H3	L1
16	77.2	60	10	45	5.5	38.3	34.6	20	43
25	102	80	14	59	6.6	52.3	50.6	32	44
40	119	100	18	76	9	64.5	56	36	54

For size	L2	L3	T1	≅G1	CRC <sup>1)</sup>	Weight [g]	Part no.	Type
16	20	30	3	2.5	1	80	1434906	EAHH-P1-16
25	20	30	4	2.5	1	150	1434907	EAHH-P1-25
40	20	40	4	4	1	240	1434908	EAHH-P1-40

1) Corrosion resistance class CRC 1 to Festo standard FN 940070  
Low corrosion stress. Dry internal application or transport and storage protection. Also applies to parts behind coverings, in the non-visible interior area, and parts which are covered in the application (e.g. drive trunnions).

## Accessories

### Swivel mounting EAHS

Material:  
Galvanised steel  
RoHS-compliant

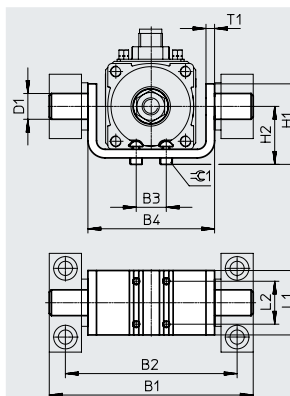

The position is freely selectable along the entire cylinder length L2.

#### Dimensions and ordering data

For size	B1	B2	B3	B4	D1 ∅ e9	H1	H2
16	71	60	10	45	8	33	21
25	95	80	14	59	12	37.5	27
40	118	100	18	76	16	55	36.5

For size	L1	L2	T1	≡G1	CRC <sup>1)</sup>	Weight [g]	Part no.	Type
16	30	20	3	2.5	1	80	1434909	EAHS-P1-16
25	30	20	4	2.5	1	140	1434910	EAHS-P1-25
40	40	20	4	4	1	260	1434911	EAHS-P1-40

1) Corrosion resistance class CRC 1 to Festo standard FN 940070

Low corrosion stress. Dry internal application or transport and storage protection. Also applies to parts behind coverings, in the non-visible interior area, and parts which are covered in the application (e.g. drive trunnions).

## Accessories

### Adapter kit EAHA

Material: Galvanised steel  
RoHS-compliant

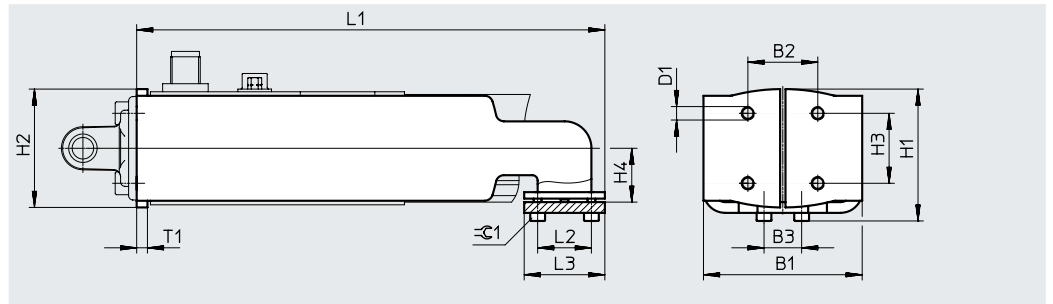

#### Dimensions and ordering data

For size	B1	B2	B3	D1	H1	H2	H3	H4
16	45	18	10	M4	35.9	29.8	18	15
25	59	26	14	M5	49	44	26	20
40	76	38	18	M6	66.9	60.8	38	27.5

For size	L1	L2	L3	T1	≡C1	CRC <sup>1)</sup>	Weight [g]	Part no.	Type
16	139	20	30	3	2.5	1	210	<b>1434900</b>	<b>EAHA-P1-16</b>
25	174	20	30	4	2.5	1	480	<b>1434901</b>	<b>EAHA-P1-25</b>
40	193.4	20	40	4	4	1	770	<b>1434902</b>	<b>EAHA-P1-40</b>

1) Corrosion resistance class CRC 1 to Festo standard FN 940070

Low corrosion stress. Dry internal application or transport and storage protection. Also applies to parts behind coverings, in the non-visible interior area, and parts which are covered in the application (e.g. drive trunnions).

## Accessories

### Trunnion flange ZNCF

Material:  
ZNCF: stainless steel casting

Free of copper and PTFE  
RoHS-compliant

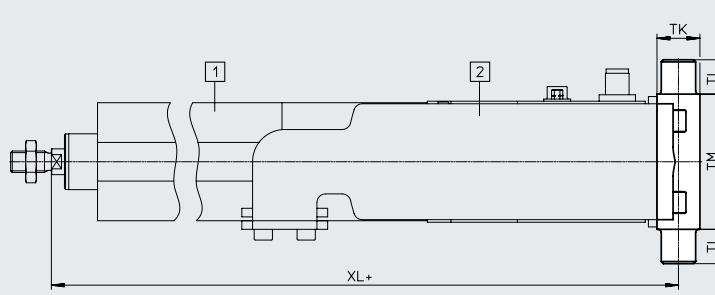
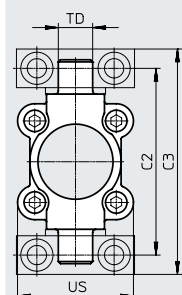

- [1] Electric cylinder EPCO
- [2] Adapter kit EAHA
- + = plus stroke length

The trunnion flange ZNCF cannot be mounted when turned by 90°.

#### Dimensions and ordering data

For size	C2	C3	TD ∅ e9	TK	TL	TM	US	XL			CRC <sup>1)</sup>	Weight [g]	Part no.	Type	
								EPCO-...	-E	-B					-EB
40	87	105	16	20	16	63	54	306.7	335.7	356.7	371.2	2	285	174412	ZNCF-40

1) Corrosion resistance class CRC 2 to Festo standard FN 940070  
Moderate corrosion stress. Indoor applications in which condensation can occur. External visible parts with primarily decorative surface requirements in direct contact with a normal industrial environment.

### Trunnion support LNZG

Material:  
Trunnion support: anodised aluminium  
Plain bearing: plastic  
Free of copper and PTFE  
RoHS-compliant

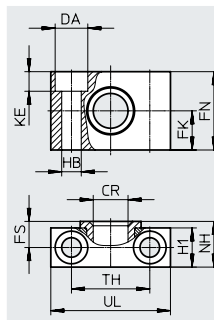
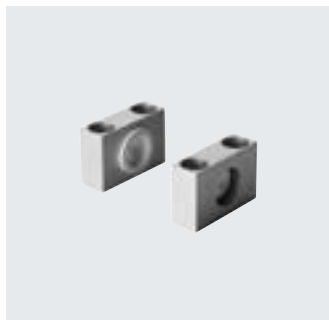

#### Dimensions and ordering data

For size	CR ∅ D11	DA ∅ H13	FK ∅ ±0.1	FN	FS	H1	HB ∅ H13	KE	NH	TH ±0.2	UL	CRC <sup>1)</sup>	Weight [g]	Part no.	Type
25	12	11	15	30	10.5	15	6.6	6.8	18	32	46	2	83	32959	LNZG-32
40	16	15	18	36	12	18	9	9	21	36	55	2	129	32960	LNZG-40/50

1) Corrosion resistance class CRC 2 to Festo standard FN 940070  
Moderate corrosion stress. Indoor applications in which condensation can occur. External visible parts with primarily decorative surface requirements in direct contact with a normal industrial environment.



## Accessories

### Swivel flange SNCS

Material:  
Die-cast aluminium

Free of copper and PTFE  
RoHS-compliant

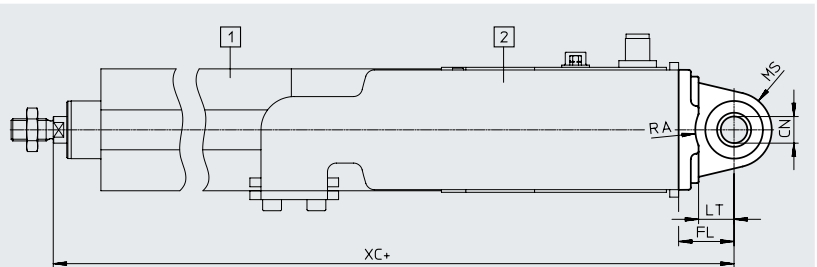
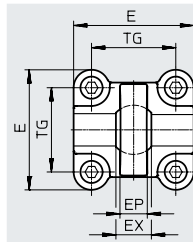

- [1] Electric cylinder EPCO
- [2] Adapter kit EAHA
- + = plus stroke length

#### Dimensions and ordering data

For size	CN ∅	E	EP +0.2	EX	FL ±0.2	LT	MS	RA +1	TG
40	12 <sup>+0.015</sup>	54 <sup>-0.5</sup>	12	16	25	16	17 <sup>-0.5</sup>	17.5	38

For size	XC				CRC <sup>1)</sup>	Weight [g]	Part no.	Type
	EPCO-...	-E	-B	-EB				
40	321.7	350.7	371.7	386.2	1	122	174398	SNCS-40

1) Corrosion resistance class CRC 1 to Festo standard FN 940070

Low corrosion stress. Dry internal application or transport and storage protection. Also applies to parts behind coverings, in the non-visible interior area, and parts which are covered in the application (e.g. drive trunnions).

### Swivel flange SNCL

Material:  
Wrought aluminium alloy

Free of copper and PTFE  
RoHS-compliant

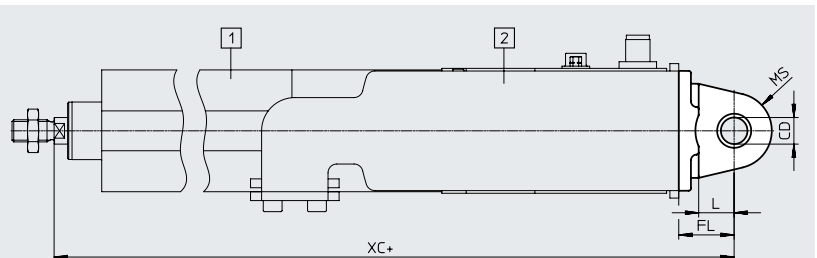
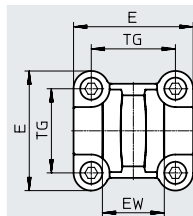

- [1] Electric cylinder EPCO
- [2] Adapter kit EAHA
- + = plus stroke length

#### Dimensions and ordering data

For size	CD ∅ H9	EW h12	FL ±0.2	L	MR -0.5	XC				CRC <sup>1)</sup>	Weight [g]	Part no.	Type
						EPCO-...	-E	-B	-EB				
16	6	12	16	10	6	237	237	263	263	2	21	537791	SNCL-16
25	8	16	20	14	8	269.6	298	318	331	2	41	537793	SNCL-25
40	12	28	25	16	12	321.7	350.7	371.7	386.2	1	95	174405	SNCL-40

1) Corrosion resistance class CRC 1 to Festo standard FN 940070

Low corrosion stress. Dry internal application or transport and storage protection. Also applies to parts behind coverings, in the non-visible interior area, and parts which are covered in the application (e.g. drive trunnions).

Corrosion resistance class CRC 2 to Festo standard FN 940070

Moderate corrosion stress. Indoor applications in which condensation can occur. External visible parts with primarily decorative surface requirements in direct contact with a normal industrial environment.

Accessories

Swivel flange SNCB

Material:  
Die-cast aluminium

Free of copper and PTFE  
RoHS-compliant

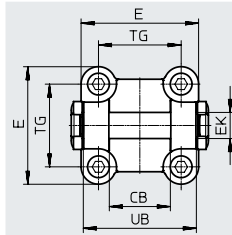

- [1] Electric cylinder EPCO
- [2] Adapter kit EAHA
- + = plus stroke length

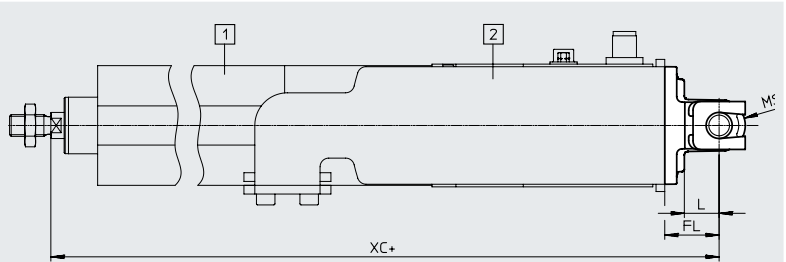



Dimensions and ordering data

For size	CB	EK ∅ e8	FL ±0.2	L	MR	UB h14	XC			CRC <sup>1)</sup>	Weight [g]	Part no.	Type	
							EPCO-...	-E	-B					-EB
40	28	12	25	16	12	52	321.7	350.7	371.7	386.2	1	155	174391	SNCB-40

1) Corrosion resistance class CRC 1 to Festo standard FN 940070

Low corrosion stress. Dry internal application or transport and storage protection. Also applies to parts behind coverings, in the non-visible interior area, and parts which are covered in the application (e.g. drive trunnions).

Ordering data – Mounting components

Ordering data – Mounting components				Data sheets → Internet: clevis foot			
Designation	For size	Part no.	Type	Designation	For size	Part no.	Type
<b>Clevis foot LBG</b>				<b>Right angle clevis foot LQG</b>			
	40	31762	LBG-40		40	31769	LQG-40
<b>Clevis foot LBN</b>							
	16	6058	LBN-12/16				
	25	6059	LBN-20/25				
	40	195861	LBN-40				

## Accessories

### Ordering data – Piston rod attachments

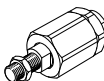
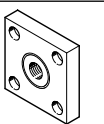
Designation	For size	Part no.	Type
<b>Rod eye SGS</b>			
	16	9254	SGS-M6
	25	9255	SGS-M8
	40	9261	SGS-M10x1.25
<b>Self-aligning rod coupler FK</b>			
	16	2061	FK-M6
	25	2062	FK-M8
	40	6140	FK-M10x1.25
<b>Coupling piece KSG</b>			
	40	32963	KSG-M10x1.25

Data sheets → Internet: piston rod attachment

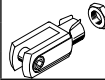
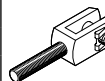
Designation	For size	Part no.	Type
<b>Rod clevis SG</b>			
	16	3110	SG-M6
	25	3111	SG-M8
	40	6144	SG-M10x1.25
<b>Rod clevis SGA</b>			
	40	32954	SGA-M10x1.25

### Ordering data – Guide unit

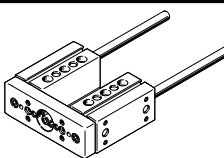
	For size	Stroke [mm]	Part no.	Type
	16	50	3192932	EAGF-P1-KF-16-50
		100	3192934	EAGF-P1-KF-16-100
		150	3192936	EAGF-P1-KF-16-150
		200	3192938	EAGF-P1-KF-16-200
		75, 125, 175	3192939	EAGF-P1-KF-16-
	25	50	3192943	EAGF-P1-KF-25-50
		100	3192945	EAGF-P1-KF-25-100
		150	3192947	EAGF-P1-KF-25-150
		200	3192949	EAGF-P1-KF-25-200
		300	3192951	EAGF-P1-KF-25-300
		75, 125, 175, 250	3192952	EAGF-P1-KF-25-
	40	50	3192955	EAGF-P1-KF-40-50
		100	3192957	EAGF-P1-KF-40-100
		150	3192959	EAGF-P1-KF-40-150
		200	3192961	EAGF-P1-KF-40-200
		300	3192963	EAGF-P1-KF-40-300
		75, 125, 175, 250 350, 400	3192966	EAGF-P1-KF-40-

Data sheets → Internet: eagf

## Accessories

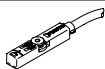
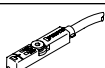
Ordering data – Proximity switches for T-slot, magneto-resistive						Data sheets → Internet: smt
	Type of mounting	Switching output	Electrical connection	Cable length [m]	Part no.	Type
<b>N/O contact</b>						
	Insertable in the slot from above, flush with the cylinder profile, short design	PNP	Cable, 3-wire	2.5	574335	SMT-8M-A-PS-24V-E-2.5-OE
			Plug M8x1, 3-pin	0.3	574334	SMT-8M-A-PS-24V-E-0.3-M8D
			Plug M12x1, 3-pin	0.3	574337	SMT-8M-A-PS-24V-E-0.3-M12
		NPN	Cable, 3-wire	2.5	574338	SMT-8M-A-NS-24V-E-2.5-OE
			Plug M8x1, 3-pin	0.3	574339	SMT-8M-A-NS-24V-E-0.3-M8D
<b>N/C contact</b>						
	Insertable in the slot from above, flush with the cylinder profile, short design	PNP	Cable, 3-wire	7.5	574340	SMT-8M-A-PO-24V-E-7,5-OE

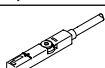
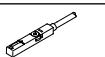
Ordering data – Proximity switches for T-slot, magnetic reed						Data sheets → Internet: sme
	Type of mounting	Switching output	Electrical connection	Cable length [m]	Part no.	Type
<b>N/O contact</b>						
	Insertable in the slot from above, flush with the cylinder profile	Contacting	Cable, 3-wire	2.5	543862	SME-8M-DS-24V-K-2.5-OE
				5.0	543863	SME-8M-DS-24V-K-5.0-OE
			Cable, 2-wire	2.5	543872	SME-8M-ZS-24V-K-2.5-OE
			Plug M8x1, 3-pin	0.3	543861	SME-8M-DS-24V-K-0.3-M8D
<b>N/C contact</b>						
	Insertable in the slot lengthwise, flush with the cylinder profile	Contacting	Cable, 3-wire	7.5	160251	SME-8-O-K-LED-24

 **Note**

Position sensing is only possible in combination with characteristic "A"  
→ page 26 (modular product system)

Ordering data – Connecting cable					Data sheets → Internet: nebu
	Description	Connection	Cable length [m]	Part no.	Type
<b>Straight socket</b>					
	Union nut M8, both ends	3-pin	0.5	541346	NEBU-M8G3-K-0.5-M8G3
			1.0	541347	NEBU-M8G3-K-1-M8G3
			2.5	541348	NEBU-M8G3-K-2.5-M8G3
			5.0	541349	NEBU-M8G3-K-5-M8G3

## Accessories

### Sensor mounting

The sensor mountings can only be attached within the highlighted area due to the asymmetry of the internal magnet.

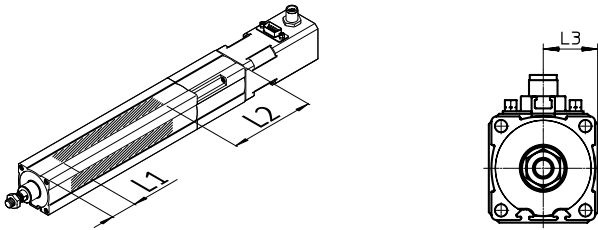

The proximity switches may not switch reliably if they are mounted outside of this area.

The overall length of the sensor rail SAMH corresponds to the length of the sensing range plus approx. 10 mm adjustment range on either side for the proximity switches.

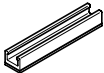

Size	L1	L2	L3
16	29	95	15
25	33	121	20
40	40	150	27.5

### Ordering data – Sensor mounting for T-slot

	For size	Description	Length [mm]	Part no.	Type
<b>Sensor rail</b>					
	16, 25, 40	Size 25 can only be used with proximity switch SMT-8 (magneto-resistive).	50	<b>1600093</b>	<b>SAMH-N8-SR-50</b>
			100	<b>1600118</b>	<b>SAMH-N8-SR-100</b>
<b>Mounting kit</b>					
	16, 25, 40	–	35	<b>525565</b>	<b>CRSMB-8-32/100</b>

## Accessories

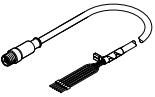
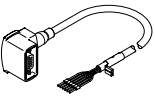
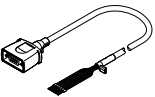
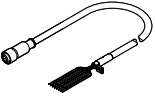
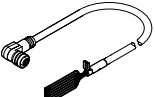
Ordering data – Cables <sup>1)</sup>					
	For size	Description	Cable length [m]	Part no.	Type
<b>Motor cable</b>					
	16	<b>Straight plug</b> • Min. bending radius: 62 mm • Suitable for energy chains • Ambient temp.: -40 ... +80°C	1.5	1449600	NEBM-SM12G8-E-1.5-Q5-LE6
			2.5	1449601	NEBM-SM12G8-E-2.5-Q5-LE6
			5.0	1449602	NEBM-SM12G8-E-5-Q5-LE6
			7.0	1449603	NEBM-SM12G8-E-7-Q5-LE6
			10.0	1449604	NEBM-SM12G8-E-10-Q5-LE6
	25/-40	<b>Angled plug</b> • Min. bending radius: 62 mm • Suitable for energy chains • Ambient temp.: -40 ... +80°C	1.5	1450736	NEBM-S1W9-E-1.5-Q5-LE6
			2.5	1450737	NEBM-S1W9-E-2.5-Q5-LE6
			5.0	1450738	NEBM-S1W9-E-5-Q5-LE6
			7.0	1450739	NEBM-S1W9-E-7-Q5-LE6
			10.0	1450740	NEBM-S1W9-E-10-Q5-LE6
		<b>Straight plug</b> • Min. bending radius: 62 mm • Suitable for energy chains • Ambient temp.: -40 ... +80°C	1.5	1450368	NEBM-S1G9-E-1.5-Q5-LE6
			2.5	1450369	NEBM-S1G9-E-2.5-Q5-LE6
			5.0	1450370	NEBM-S1G9-E-5-Q5-LE6
			7.0	1450371	NEBM-S1G9-E-7-Q5-LE6
			10.0	1450372	NEBM-S1G9-E-10-Q5-LE6
<b>Encoder cable</b>					
	16/-25/-40	<b>Straight plug</b> • Min. bending radius: 68 mm • Suitable for energy chains • Ambient temp.: -40 ... +80°C	1.5	1451586	NEBM-M12G8-E-1.5-LE8
			2.5	1451587	NEBM-M12G8-E-2.5-LE8
			5.0	1451588	NEBM-M12G8-E-5-LE8
			7.0	1451589	NEBM-M12G8-E-7-LE8
			10.0	1451590	NEBM-M12G8-E-10-LE8
	25/-40	<b>Angled plug</b> • Min. bending radius: 68 mm • Suitable for energy chains • Ambient temp.: -40 ... +80°C	1.5	1451674	NEBM-M12W8-E-1.5-LE8
			2.5	1451675	NEBM-M12W8-E-2.5-LE8
			5.0	1451676	NEBM-M12W8-E-5-LE8
			7.0	1451677	NEBM-M12W8-E-7-LE8
			10.0	1451678	NEBM-M12W8-E-10-LE8

1) Other cable lengths on request.

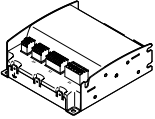
Ordering data – Motor controller				Data sheets → Internet: cmmo
	Description	Part no.	Type	
	<b>With I/O interface</b>			
	Switching input/output PNP	1512316	CMMO-ST-C5-1-DIOP	
	Switching input/output NPN	1512317	CMMO-ST-C5-1-DION	
	<b>With IO-Link</b>			
Switching input/output PNP	1512320	CMMO-ST-C5-1-LKP		