

Stepper motors EMMS-ST



# Stepper motors EMMS-ST

Key features

FESTO

## Everything from a single source

Stepper motors EMMS-ST

→ 4



- Corresponds to IEC 60034
- 2-phase hybrid technology
- Optionally integrated encoder (closed loop)
- Sinusoidal current impressing
- Optionally with holding brake
- Protection class: IP54



## Gear unit EMGA-SST

→ 13



- Planetary gear unit
- Gear ratio  $i = 3$  and  $5$ , available ex-stock
- Other ratios and versions on request
- Life-time lubrication
- Protection class: IP54

## Motor controller CMMS-ST

→ Internet: [cmms-st](http://cmms-st)



- Position controller with setpoint specifications for position, speed and torque
- Integrated encoder (closed loop), in other words no step losses, current following errors are corrected
- Interfaces:
  - I/O interface
  - CANopen
  - Profibus DP
  - DeviceNet

## Power supply units SVG

→ Internet: [svg](http://svg)



- Sturdy mechanical system
- Input voltage 230 V AC / 115 V AC
- Output voltage 24, 48 V DC
- Output current 5, 10, 20 A

## Motor and encoder cables NEBM

→ 14



- Can be used in a wide temperature range
- Screened cables
- Suitable for use with energy chains
- Protection class IP65

## Axial kits EAMM

→ Internet: [eamm](http://eamm)



- Defined kits for all electro-mechanical axes from Festo

PROFIBUS®, DeviceNet®, CANopen® is a registered trademark of its respective trademark holder in certain countries.

# Stepper motors EMMS-ST

Type codes

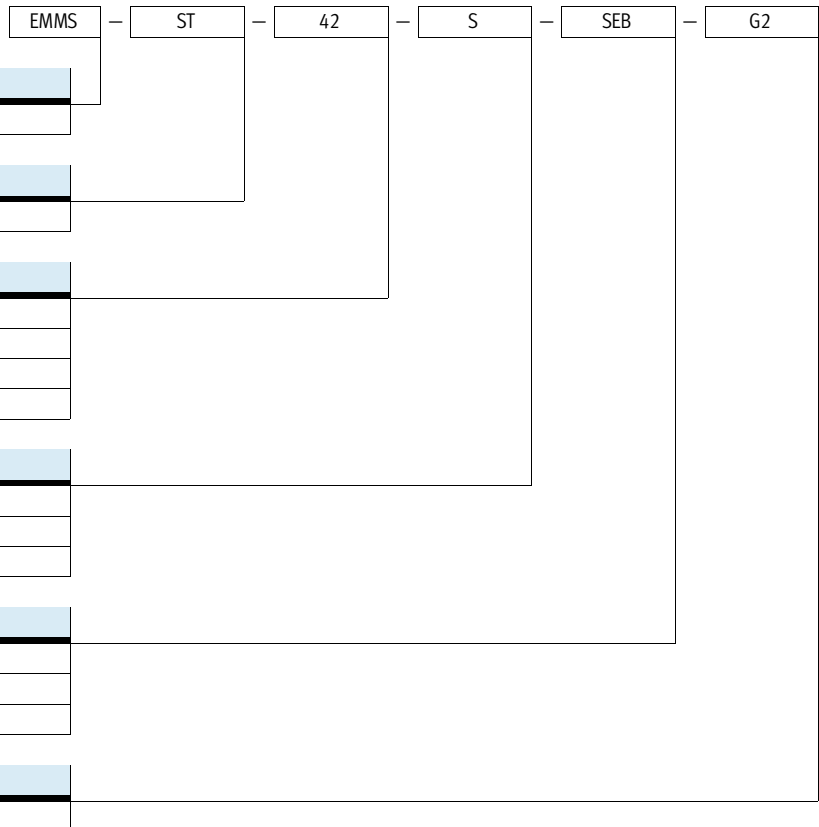

# Stepper motors EMMS-ST

Technical data

FESTO

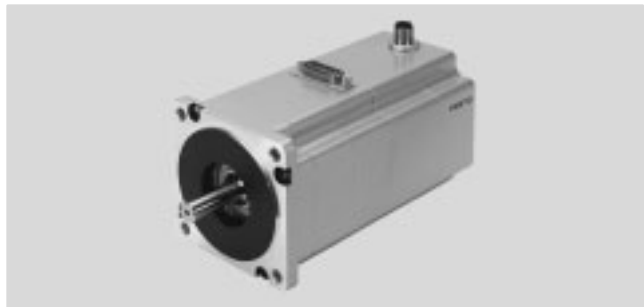

General technical data			
Size		28	42
<b>Motor</b>			
Nominal voltage	[V DC]	48	48
Nominal current	[A]	1.4	1.8
Max. rotational speed <sup>1)</sup>	[rpm]	6,000	1,740
Holding torque	[Nm]	0.09	0.5
Stepper angle	[°]	1.8 ±5%	1.8 ±5%
Winding resistance	[Ω]	2.3 ±15%	1.75 ±15%
Winding inductance	[mH]	1.4	3.3
Output mass moment of inertia	[kgcm <sup>2</sup> ]	0.018/0.025 <sup>2)</sup>	0.082/0.095 <sup>2)</sup>
Radial load on shaft	[N]	20	20
Axial load on shaft	[N]	7	7
Mass moment of inertia of rotor	[kgcm <sup>2</sup> ]	0.018	0.082
<b>Brake</b>			
Operating voltage	[V DC]	24 ±10%	24 ±10%
Power	[W]	8	8
Holding torque	[Nm]	0.2	0.4
Mass moment of inertia	[kgcm <sup>2</sup> ]	0.007	0.013
Response delay	[ms]	2/6	2/6
Separation time	[ms]	10	10

1) Theoretical max. rotational speed while idling at nominal voltage

2) With brake

Size		57-S	57-M
<b>Motor</b>			
Nominal voltage	[V DC]	48	
Nominal current	[A]	5	
Max. rotational speed <sup>1)</sup>	[rpm]	2,720	1,940
Holding torque	[Nm]	0.8	1.4
Stepper angle	[°]	1.8 ±5%	
Winding resistance	[Ω]	0.15 ±10%	0.25 ±10%
Winding inductance	[mH]	0.5	0.95
Output mass moment of inertia	[kgcm <sup>2</sup> ]	0.29/0.30 <sup>2)</sup>	0.48/0.5 <sup>2)</sup>
Radial load on shaft	[N]	52	
Axial load on shaft	[N]	10	
Mass moment of inertia of rotor	[kgcm <sup>2</sup> ]	0.29	0.48
<b>Brake</b>			
Operating voltage	[V DC]	24 ±10%	
Power	[W]	8	10
Holding torque	[Nm]	0.4	1
Mass moment of inertia	[kgcm <sup>2</sup> ]	0.01	0.02
Response delay	[ms]	2/6	2/6
Separation time	[ms]	10	12

1) Theoretical max. rotational speed while idling at nominal voltage

2) With brake

# Stepper motors EMMS-ST

Technical data

FESTO

General technical data				
Size		87-S	87-M	87-L
<b>Motor</b>				
Nominal voltage	[V DC]	48		
Nominal current	[A]	9.5		
Max. rotational speed <sup>1)</sup>	[rpm]	2,130	550	430
Holding torque	[Nm]	2.5	5.9	9.3
Stepper angle	[°]	1.8 ±5%		
Winding resistance	[Ω]	0.1 ±10%	0.23 ±10%	0.23 ±10%
Winding inductance	[mH]	0.45	2.6	2.7
Output mass moment of inertia	[kgcm <sup>2</sup> ]	1/1.07 <sup>2)</sup>	1.9/1.97 <sup>2)</sup>	3/3.07 <sup>2)</sup>
Radial load on shaft	[N]	200		
Axial load on shaft	[N]	65		
Mass moment of inertia of rotor	[kgcm <sup>2</sup> ]	1	1.9	3
<b>Brake</b>				
Operating voltage	[V DC]	24 ±10%		
Power	[W]	11		
Holding torque	[Nm]	2		
Mass moment of inertia	[kgcm <sup>2</sup> ]	0.07		
Response delay	[ms]	2/6	2/6	2/6
Separation time	[ms]	25		

1) Theoretical max. rotational speed while idling at nominal voltage

2) With brake

Technical data – Encoder	
Rotary position encoder	Incremental
Rotary position encoder measuring principle	Opto-electrical
Pulses/revolution	[1/rev] 500
Interface	RS422, TTL, AB channel, zero index
Operating voltage	[V DC] 5

Weight [g]							
Size	28	42	57-S	57-M	87-S	87-M	87-L
Product weight	320	360	870	1,100	1,950	3,050	4,200
With encoder	380	450	970	1,200	2,100	3,200	4,350
With brake	320	540	1,090	1,320	2,350	3,450	4,600
With encoder and brake	380	600	1,150	1,380	2,500	3,600	5,000

Operating and environmental conditions							
Size	28	42	57-S	57-M	87-S	87-M	87-L
Insulation protection class	B						
Heat class to EN 60034-1	B						
Rated class to EN 60034-1	S1						
Protection class: Motor shaft	IP54						
Protection class: Motor housing	IP65	IP54					
Ambient temperature	[°C]	-10 ... +50					
Storage temperature	[°C]	-20 ... +70					
Relative air humidity (non-condensing)	[%]	0 ... 85					
CE marking (see declaration of conformity)	To EU EMC Directive <sup>1)</sup>						
Certification	c UL us - Recognized (OL)						
	RCM trademark						
Note on materials	RoHS-compliant						

1) For information about the applicability of the component see the manufacturer's EC declaration of conformity at: [www.festo.com/sp](http://www.festo.com/sp) → User documentation.

If the component is subject to restrictions on usage in residential, office or commercial environments or small businesses, further measures to reduce the emitted interference may be necessary.

# Stepper motors EMMS-ST

Technical data

## Pin allocation

Motor connection

Size 28

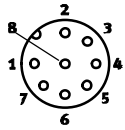

Size 42, 57

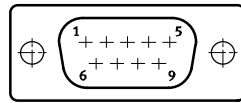

Size 87

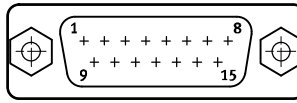

Pin	Function
1	String A
2	String A/
3	String B
4	String B/
5	n.c.
6	n.c.
7	Brake (24 V)
8	Brake (0 V)
9	–

Pin	Function
1	String A
2	String A
3	String A/
4	String A/
5	String B
6	String B
7	String B/
8	String B/
9	n.c.
10	n.c.
11	Brake (24 V)
12	Brake (0 V)
13	n.c.
14	n.c.
15	n.c.

## Encoder connection

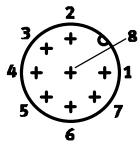

Pin	Function
1	Signal trace A
2	Signal trace A/
3	Signal trace B
4	Signal trace B/
5	0 V
6	Signal trace N
7	Signal trace N/
8	5 V

# Stepper motors EMMS-ST

Technical data

## Torque M as a function of rotational speed n

EMMS-ST-28

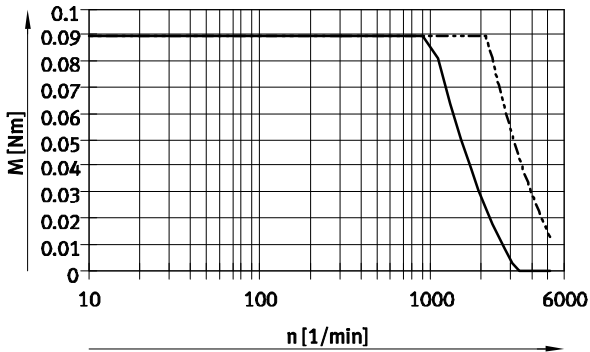

EMMS-ST-42

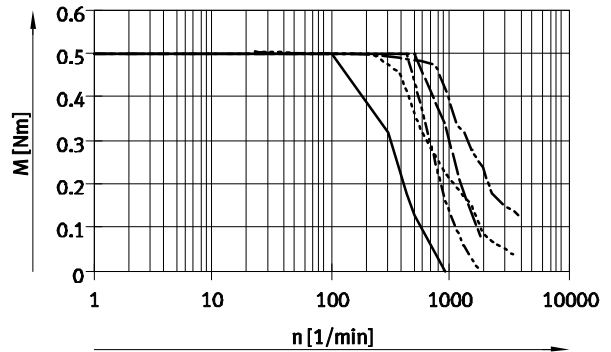

EMMS-ST-57-S

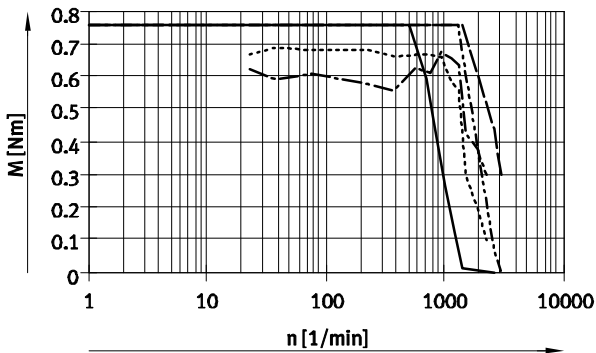

EMMS-ST-57-M

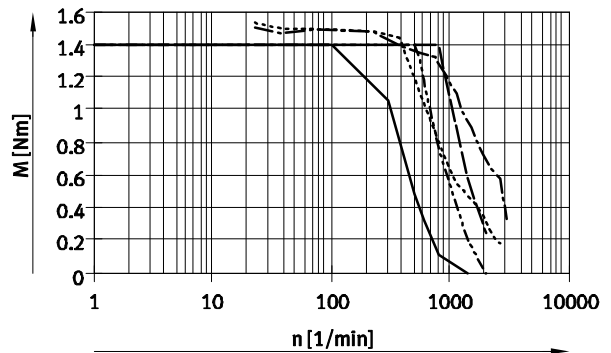

- 24 V DC
- - - 48 V DC
- 72 V DC
- · - · 24 V DC ¼ step
- · - · 48 V DC ¼ step

 Note  
 The characteristic curves apply in combination with the motor controller CMMS-ST.

# Stepper motors EMMS-ST

Technical data

## Torque M as a function of rotational speed n

EMMS-ST-87-S

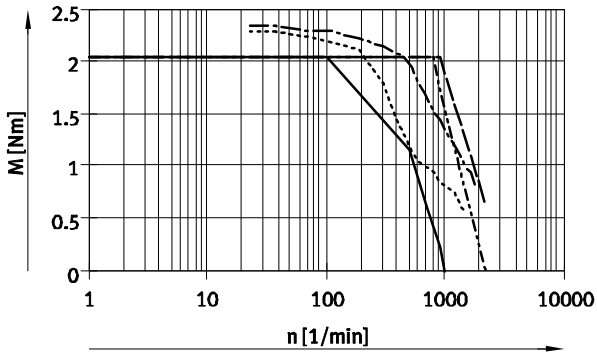

EMMS-ST-87-M

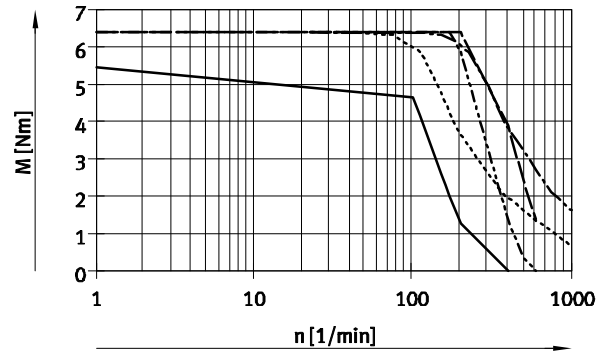

EMMS-ST-87-L

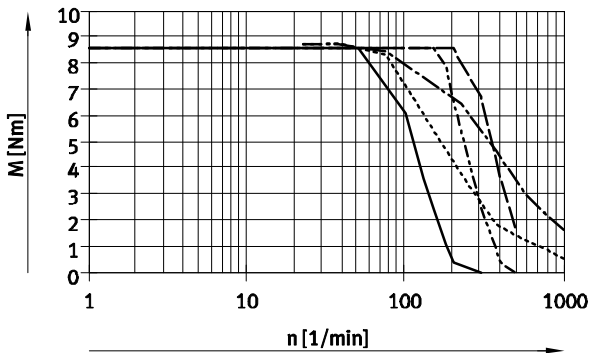

- 24 V DC
- - - 48 V DC
- · - · 72 V DC
- · - · 24 V DC 1/4 step
- · - · 48 V DC 1/4 step

**Note**  
 The characteristic curves apply in combination with the motor controller CMMS-ST.  
 The size EMMS-ST-87 is operated with the motor controller CMMS-ST with max. 8A.



# Stepper motors EMMS-ST

Technical data

## Dimensions

Download CAD data → [www.festo.com](http://www.festo.com)

Size 28  
EMMS-ST-...-S/SE

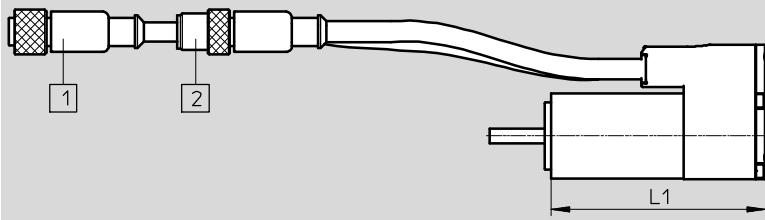

EMMS-ST-...-SB/SEB

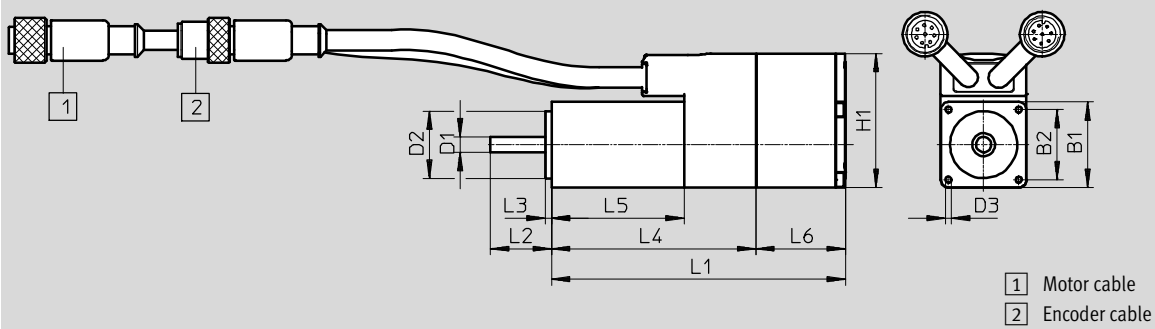

Type	B1	B2	D1 ∅	D2 ∅	D3	H1
	±1	±0.2	-0.013	-0.03		
EMMS-ST-28-L-S	28	23	5	22	M2.5x4.5	44
EMMS-ST-28-L-SE						
EMMS-ST-28-L-SB						
EMMS-ST-28-L-SEB						

Type	L1	L2	L3	L4	L5	L6
		±1		±1	±1	±0.5
EMMS-ST-28-L-S	70±1	20	2	67	43	29
EMMS-ST-28-L-SE						
EMMS-ST-28-L-SB	96±1.5					
EMMS-ST-28-L-SEB						

# Stepper motors EMMS-ST

Technical data

## Dimensions

Download CAD data → [www.festo.com](http://www.festo.com)

Sizes 42, 57, 87

EMMS-ST-...-S

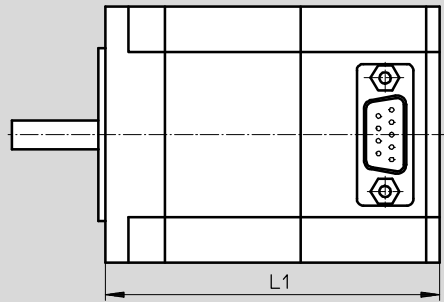

EMMS-ST-...-SB

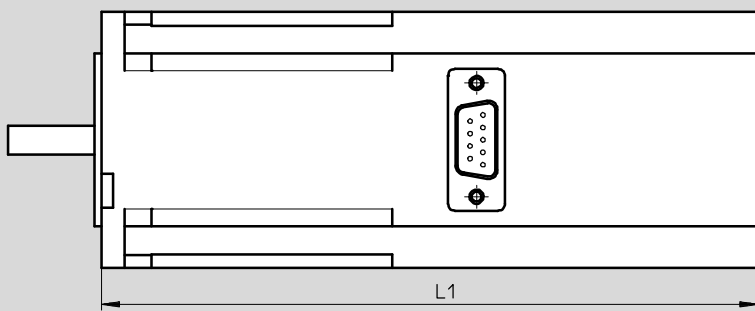

EMMS-ST-...-SE/SEB

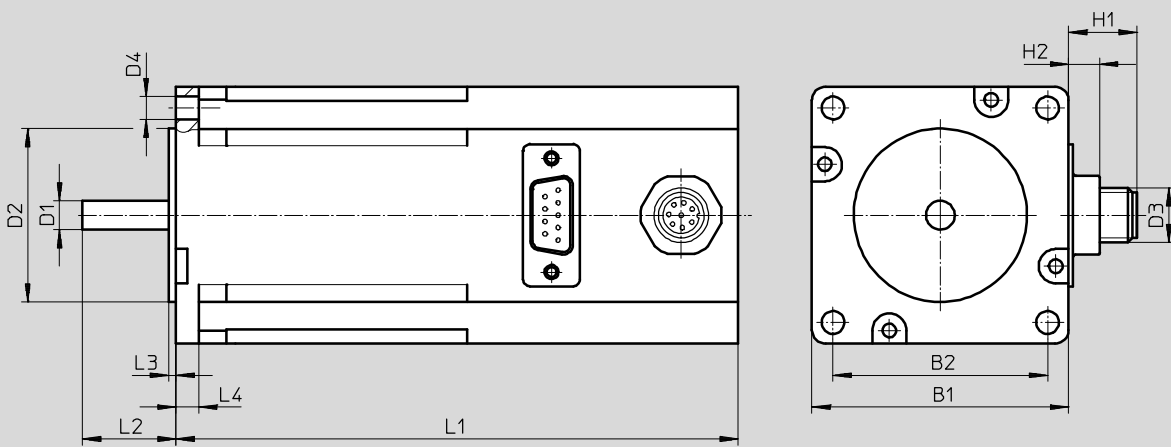

## Plug pattern

9-pin Sub-D plug  
with size 42, 57

15-pin Sub-D plug  
with size 87

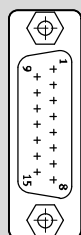
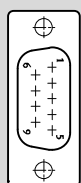

# Stepper motors EMMS-ST

Technical data

FESTO

Type	B1	B2 ±0.2	D1 ∅	D2 ∅	D3	D4 ∅
EMMS-ST-42-S-S-G2	42.3	31	5-0.012	22-0.05	-	M3x4.5
EMMS-ST-42-S-SE-G2					M12	
EMMS-ST-42-S-SB-G2					-	
EMMS-ST-42-S-SEB-G2					M12	
EMMS-ST-57-S-S-G2	56.4	47.14	6.35-0.013	38.1±0.025	-	5
EMMS-ST-57-S-SE-G2					M12	
EMMS-ST-57-S-SB-G2					-	
EMMS-ST-57-S-SEB-G2					M12	
EMMS-ST-57-M-S-G2					-	
EMMS-ST-57-M-SE-G2					M12	
EMMS-ST-57-M-SB-G2					-	
EMMS-ST-57-M-SEB-G2					M12	
EMMS-ST-87-S-S-G2	85.85	69.5	11-0.013	73-0.046	-	6.6
EMMS-ST-87-S-SE-G2					M12	
EMMS-ST-87-S-SB-G2					-	
EMMS-ST-87-S-SEB-G2					M12	
EMMS-ST-87-M-S-G2					-	
EMMS-ST-87-M-SE-G2					M12	
EMMS-ST-87-M-SB-G2					-	
EMMS-ST-87-M-SEB-G2					M12	
EMMS-ST-87-L-S-G2					-	
EMMS-ST-87-L-SE-G2					M12	
EMMS-ST-87-L-SB-G2					-	
EMMS-ST-87-L-SEB-G2					M12	

Type	H1	H2	L1	L2	L3	L4
EMMS-ST-42-S-S-G2	-	6.5	66±1	24±1	2	-
EMMS-ST-42-S-SE-G2	13		94±1.2			
EMMS-ST-42-S-SB-G2	-		114±1.3			
EMMS-ST-42-S-SEB-G2	13		127±1.3			
EMMS-ST-57-S-S-G2	-	6.5	73.5±0.8	20.6±0.5	1.6	5
EMMS-ST-57-S-SE-G2	13		102.5±1.1			
EMMS-ST-57-S-SB-G2	-		123.5±1.1			
EMMS-ST-57-S-SEB-G2	13		138±1.1			
EMMS-ST-57-M-S-G2	-		95±0.8			
EMMS-ST-57-M-SE-G2	13		124±1.1			
EMMS-ST-57-M-SB-G2	-		145±1.1			
EMMS-ST-57-M-SEB-G2	13		159.5±1.1			
EMMS-ST-87-S-S-G2	-	6.5	82.6±1	27±1	2	8.38
EMMS-ST-87-S-SE-G2	13		112.6±1.3			
EMMS-ST-87-S-SB-G2	-		132.6±1.3			
EMMS-ST-87-S-SEB-G2	13		152.6±1.3			
EMMS-ST-87-M-S-G2	-		114.9±1			
EMMS-ST-87-M-SE-G2	13		144.9±1.3			
EMMS-ST-87-M-SB-G2	-		164.9±1.3			
EMMS-ST-87-M-SEB-G2	13		184.9±1.3			
EMMS-ST-87-L-S-G2	-		144.9±1			
EMMS-ST-87-L-SE-G2	13		174.9±1.3			
EMMS-ST-87-L-SB-G2	-		194.9±1.3			
EMMS-ST-87-L-SEB-G2	13		214.9±1.3			

# Stepper motors EMMS-ST

Technical data

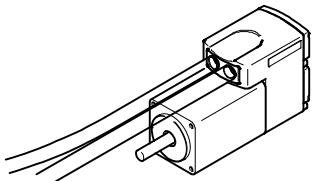
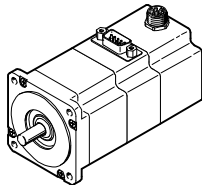

Ordering data						
	Size	Variant			Part No.	Type
		Basic design	With encoder	With brake		
	28	■			1451384	EMMS-ST-28-L-S
			■		1430663	EMMS-ST-28-L-SE
				■	1451383	EMMS-ST-28-L-SB
			■	■	1451382	EMMS-ST-28-L-SEB
	42	■			1370470	EMMS-ST-42-S-S-G2
			■		1370471	EMMS-ST-42-S-SE-G2
				■	1370472	EMMS-ST-42-S-SB-G2
			■	■	1370473	EMMS-ST-42-S-SEB-G2
	57	■			1370474	EMMS-ST-57-S-S-G2
			■		1370475	EMMS-ST-57-S-SE-G2
				■	1370476	EMMS-ST-57-S-SB-G2
			■	■	1370477	EMMS-ST-57-S-SEB-G2
		■			1370478	EMMS-ST-57-M-S-G2
			■		1370479	EMMS-ST-57-M-SE-G2
				■	1370480	EMMS-ST-57-M-SB-G2
			■	■	1370481	EMMS-ST-57-M-SEB-G2
	87	■			1370482	EMMS-ST-87-S-S-G2
			■		1370483	EMMS-ST-87-S-SE-G2
				■	1370484	EMMS-ST-87-S-SB-G2
			■	■	1370485	EMMS-ST-87-S-SEB-G2
		■			1370486	EMMS-ST-87-M-S-G2
			■		1370487	EMMS-ST-87-M-SE-G2
				■	1370488	EMMS-ST-87-M-SB-G2
		■	■	1370489	EMMS-ST-87-M-SEB-G2	
■				1370490	EMMS-ST-87-L-S-G2	
		■		1370491	EMMS-ST-87-L-SE-G2	
		■	1370493	EMMS-ST-87-L-SB-G2		
	■	■	1370494	EMMS-ST-87-L-SEB-G2		

# Stepper motors EMMS-ST

Accessories

FESTO

## Gear unit EMGA



### General technical data

For motor size	42		57		87		
	EMGA-40-P-G...		EMGA-60-P-G...		EMGA-80-P-G...		
Gear unit type							
Gear ratio	[i]	3	5	3	5	3	5
Continuous output torque <sup>1)</sup>	[Nm]	11	14	22	22	85	110
Max. output torque	[Nm]	17.6	22	35.2	35.2	136	176
Torsional rigidity	[Nm/arcmin]	1		2.3		6	
Torsional backlash	[deg]	0.25		0.17		0.12	
Moment of inertia <sup>2)</sup>	[kgcm <sup>2</sup> ]	0.031	0.019	0.135	0.078	0.77	0.45
Efficiency	[%]	98					
Operating temperature <sup>3)</sup>	[°C]	-25 ... +90					
Protection class		IP54					

- 1) At the output shaft
- 2) In relation to the drive shaft
- 3) Note the temperature range of the motor

### Dimensions

Download CAD data → [www.festo.com](http://www.festo.com)

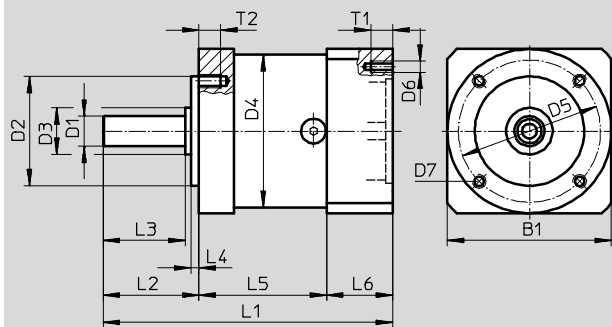

For size	B1	D1	D2	D3	D4	D5	D6	D7	L1	L2	L3	L4	L5	L6	T1	T2
		∅	∅	∅	∅	∅			±1.5		±0.2	±0.2				
42	40	10	26	12	40	34	∅3.4	M4	92.5	26±0.6	23	2	39	27.5	5	6
57	60	11	40	17	60	52	M4	M5	106	35±0.8	30	3	47	24	8	8
87	90	20	60	25	80	70	M5	M6	135.5	40±0.8	36	3	60	35.5	12	10

### Ordering data

For size	Gear ratio	Part No.	Type
42	3	549428	EMGA-40-P-G3-SST-42
	5	549429	EMGA-40-P-G5-SST-42
57	3	549430	EMGA-60-P-G3-SST-57
	5	549431	EMGA-60-P-G5-SST-57
87	3	549432	EMGA-80-P-G3-SST-87
	5	549433	EMGA-80-P-G5-SST-87

# Stepper motors EMMS-ST

Accessories

FESTO

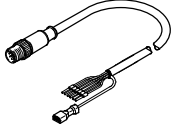
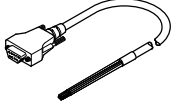
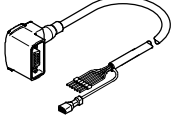
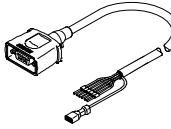
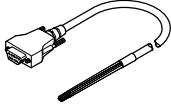
Ordering data				
	Description	Cable length [m]	Part No.	Type
Motor cable				
For EMMS-ST-28				
and motor controller CMMO-ST				
	Straight plug – Min. bending radius: 62 mm – Suitable for use with energy chains – Ambient temperature: –40 ... +80 °C	1.5	1449600	NEBM-M12G8-E-1.5-Q5-LE6
		2.5	1449601	NEBM-M12G8-E-2.5-Q5-LE6
		5	1449602	NEBM-M12G8-E-5-Q5-LE6
		7	1449603	NEBM-M12G8-E-7-Q5-LE6
		10	1449604	NEBM-M12G8-E-10-Q5-LE6
		X length <sup>1)</sup>	1449605	NEBM-M12G8-E-...-Q5-LE6
For EMMS-ST-42/57				
and motor controller CMMS-ST				
	Straight plug – Min. bending radius: 58 mm – Suitable for use with energy chains – Ambient temperature: –40 ... +70 °C	5	550740	NEBM-S1G9-E-5-LE6
		10	550741	NEBM-S1G9-E-10-LE6
		15	550742	NEBM-S1G9-E-15-LE6
		X length <sup>1)</sup>	550743	NEBM-S1G9-E-...-LE6
and motor controller CMMO-ST				
	Angled plug – Min. bending radius: 62 mm – Suitable for use with energy chains – Ambient temperature: –40 ... +80 °C	1.5	1450736	NEBM-S1W9-E-1.5-Q5-LE6
		2.5	1450737	NEBM-S1W9-E-2.5-Q5-LE6
		5	1450738	NEBM-S1W9-E-5-Q5-LE6
		7	1450739	NEBM-S1W9-E-7-Q5-LE6
		10	1450740	NEBM-S1W9-E-10-Q5-LE6
X length <sup>1)</sup>	1450741	NEBM-S1W9-E-...-Q5-LE6		
	Straight plug – Min. bending radius: 62 mm – Suitable for use with energy chains – Ambient temperature: –40 ... +80 °C	1.5	1450368	NEBM-S1G9-E-1.5-Q5-LE6
		2.5	1450369	NEBM-S1G9-E-2.5-Q5-LE6
		5	1450370	NEBM-S1G9-E-5-Q5-LE6
		7	1450371	NEBM-S1G9-E-7-Q5-LE6
		10	1450372	NEBM-S1G9-E-10-Q5-LE6
		X length <sup>1)</sup>	1450373	NEBM-S1G9-E-...-Q5-LE6
For EMMS-ST-87				
and motor controller CMMS-ST				
	Straight plug – Min. bending radius: 70 mm – Suitable for use with energy chains – Ambient temperature: –30 ... +70 °C	5	550744	NEBM-S1G15-E-5-LE6
		10	550745	NEBM-S1G15-E-10-LE6
		15	550746	NEBM-S1G15-E-15-LE6
		X length <sup>1)</sup>	550747	NEBM-S1G15-E-...-LE6

1) Max. 25 m. Available in 0.1 m increments.

# Stepper motors EMMS-ST

Accessories

FESTO

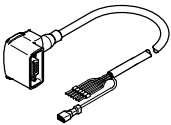
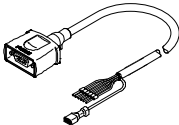
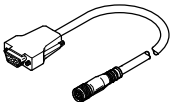
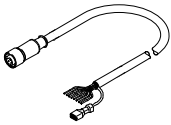
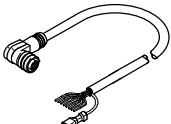
Ordering data				
	Description	Cable length [m]	Part No.	Type
Motor cable				
For EMMS-ST-87				
and motor controller CMMO-ST				
	Angled plug			
	– Min. bending radius: 80 mm	1.5	1450943	NEBM-S1W15-E-1.5-Q7-LE6
	– Suitable for use with energy chains	2.5	1450944	NEBM-S1W15-E-2.5-Q7-LE6
		5	1450945	NEBM-S1W15-E-5-Q7-LE6
	– Ambient temperature: –40 ... +80 °C	7	1450946	NEBM-S1W15-E-7-Q7-LE6
		10	1450947	NEBM-S1W15-E-10-Q7-LE6
		X length <sup>1)</sup>	1450948	NEBM-S1W15-E-...-Q7-LE6
	Straight plug			
	– Min. bending radius: 80 mm	1.5	1450834	NEBM-S1G15-E-1.5-Q7-LE6
	– Suitable for use with energy chains	2.5	1450835	NEBM-S1G15-E-2.5-Q7-LE6
		5	1450836	NEBM-S1G15-E-5-Q7-LE6
	– Ambient temperature: –40 ... +80 °C	7	1450837	NEBM-S1G15-E-7-Q7-LE6
		10	1450838	NEBM-S1G15-E-10-Q7-LE6
		X length <sup>1)</sup>	1450839	NEBM-S1G15-E-...-Q7-LE6
Encoder cable				
For motor controller CMMS-ST				
	Straight plug			
	– Min. bending radius: 51 mm	5	550748	NEBM-M12G8-E-5-S1G9
	– Suitable for use with energy chains	10	550749	NEBM-M12G8-E-10-S1G9
	– Ambient temperature: –40 ... +70 °C	15	550750	NEBM-M12G8-E-15-S1G9
		X length <sup>1)</sup>	550751	NEBM-M12G8-E-...-S1G9
For motor controller CMMO-ST				
	Straight plug			
	– Min. bending radius: 68 mm	1.5	1451586	NEBM-M12G8-E-1.5-LE8
	– Suitable for use with energy chains	2.5	1451587	NEBM-M12G8-E-2.5-LE8
		5	1451588	NEBM-M12G8-E-5-LE8
	– Ambient temperature: –40 ... +80 °C	7	1451589	NEBM-M12G8-E-7-LE8
	10	1451590	NEBM-M12G8-E-10-LE8	
		X length <sup>1)</sup>	1451591	NEBM-M12G8-E-...-LE8
	Angled plug			
	– Min. bending radius: 68 mm	1.5	1451674	NEBM-M12W8-E-1.5-LE8
	– Suitable for use with energy chains	2.5	1451675	NEBM-M12W8-E-2.5-LE8
		5	1451676	NEBM-M12W8-E-5-LE8
	– Ambient temperature: –40 ... +80 °C	7	1451677	NEBM-M12W8-E-7-LE8
		10	1451678	NEBM-M12W8-E-10-LE8
		X length <sup>1)</sup>	1451679	NEBM-M12W8-E-...-LE8

1) Max. 25 m. Available in 0.1 m increments.